

HANDBOOK 4

DESIGN OF BRIDGES

**Guide to basis of bridge design related to Eurocodes
supplemented by practical examples**



LEONARDO DA VINCI PILOT PROJECT CZ/02/B/F/PP-134007

Edited by Luca SANPAOLESI & Pietro CROCE



Leonardo da Vinci Pilot Project CZ/02/B/F/PP-134007

**DEVELOPMENT OF SKILLS FACILITATING IMPLEMENTATION OF
EUROCODES**

HANDBOOK 4

DESIGN OF BRIDGES

PARTNERSHIP:

The Klokner Institute of the Czech Technical University in Prague (KI CTU),
convener, Prof. Milan Holický, Czech Republic
The Czech Chamber of Certified Engineers and Technicians Engaged in Construction
(CKAIT), Prof. Alois Materna, Czech Republic,
The Institute of Steel Constructions of the University of Technology Aachen (RWTH),
Prof. Gerhard Sedlacek, Germany
The Spanish Organisation for Scientific Research (IET), Spain, Dr. Angel Arteaga
The University of Pisa (UOP), Prof. Luca Sanpaolesi, Italy
The Netherlands Organisation for Applied Scientific Research (TNO), Prof. Ton
Vrouwenvelder, Netherlands
The Institute for Metal Constructions (IMK), Dr. Igor Kovse, Slovenia
The Building Research Establishment (BRE), Prof. Haig Gulvanessian, United
Kingdom

Pisa 10.2005

Leonardo da Vinci Pilot Project CZ/02/B/F/PP-134007
DEVELOPMENT OF SKILLS FACILITATING IMPLEMENTATION OF
EUROCODES

HANDBOOK 4

DESIGN OF BRIDGES

1 BRIDGES – ACTIONS AND LOAD COMBINATIONS (Pages I-1 to I-76)

1	FOREWORD	I-1
2	DEVELOPMENT OF THE STATIC ROAD TRAFFIC LOAD MODELS	I-1
OF EC1.2		
2.1	Static load model philosophy	I-2
2.2	Statistical analysis of European traffic data	I-2
2.3	Traffic scenarios	I-6
2.4	Extrapolation methods	I-11
	2.4.1 <i>Half-normal distribution extrapolation method</i>	I-12
	2.4.2 <i>Gumbel distribution extrapolation method</i>	I-12
	2.4.3 <i>Montecarlo method extrapolation</i>	I-13
2.5	Definition of dynamic magnification factors	I-13
	2.5.1 <i>The inherent impact factors</i>	I-14
	2.5.2 <i>The impact factors</i>	I-14
2.6	Setup and calibration of the EN 1991-2 traffic load models	I-16
2.7	Other representative traffic load values	I-17
3	THE EN 1991-2 LOAD TRAFFIC MODELS	I-17
3.1	Division of the carriageway and numbering of notional lanes	I-17
3.2	Load models for vertical loads	I-19
3.3	Load model n. 1	I-20
3.4	Load model n. 2	I-21
3.5	Load model n. 3 - Special vehicles	I-22
3.6	Load model n. 4 – Crowd loading	I-23
3.7	Characteristic values of horizontal actions	I-25
	3.7.1 <i>Braking and acceleration forces</i>	I-25
	3.7.2 <i>Centrifugal force</i>	I-25
4	COMBINATION OF MULTI-COMPONENT ACTIONS	I-25
5	DESIGN VALUES OF ACTIONS	I-28
5.1	Persistent and transient design situations	I-28
5.2	Accidental and seismic design situations	I-31
5.3	Serviceability limit states	I-32
6	DEVELOPMENT OF THE FATIGUE LOAD MODELS OF EN 1991-2	I-33
6.1	Fatigue load modelling	I-33
	6.1.1 <i>Fatigue verification methods</i>	I-34
	6.1.2 <i>Reference traffic measurements</i>	I-35
6.2	The fatigue load models of EN 1991-2	I-35
	6.2.1 <i>Calibration method</i>	I-35
	6.2.2 <i>Reference S-N curves</i>	I-36

	6.2.3	<i>Fatigue load models</i>	I-36
	6.2.4	<i>Accuracy of fatigue load models</i>	I-39
	6.2	The λ -coefficient method	I-43
	6.3	Partial safety factors γ_M	I-45
	6.4	Modeling of vehicle interactions	I-45
	6.4.1	<i>Basic assumptions</i>	I-45
	6.4.2	<i>Interaction between lorries simultaneously travelling on one lane</i>	I-46
	6.4.3	<i>Interaction between lorries simultaneously travelling on several lanes</i>	I-47
	6.4.4	<i>The time independent load spectrum</i>	I-48
	6.4.5	<i>Time independent interactions</i>	I-48
	6.4.6	<i>Some relevant results</i>	I-49
7		ACTIONS ON FOOTBRIDGES	I-50
	7.1	Field of application	I-50
	7.2	Vertical load models	I-51
	7.2.1	<i>Uniformly distributed loads</i>	I-51
	7.2.2	<i>Concentrated load</i>	I-51
	7.2.3	<i>Service vehicle</i>	I-52
	7.3	Horizontal forces - characteristic values	I-52
	7.4	Groups of traffic loads on footbridges	I-53
	7.5	Application of the load models	I-53
	7.6	Verifications regarding traffic induced deformations and vibrations for footbridges	I-53
	7.6.1	<i>Bridge-traffic interaction</i>	I-54
	7.6.2	<i>Dynamic models of pedestrian loads</i>	I-54
	7.6.2	<i>Comfort criteria</i>	I-55
	7.7	Load combinations for footbridges	I-56
8		ACTIONS ON RAILWAY BRIDGES	I-56
	8.1	Representation of actions and nature of rail traffic loads	I-56
	8.2	Vertical loads	I-57
	8.2.1	<i>Load Model 71</i>	I-57
	8.2.2	<i>Load Models SW/0 and SW/2</i>	I-58
	8.2.3	<i>Load Model "unloaded train"</i>	I-58
	8.2.4	<i>Eccentricity of vertical load models 71 and SW/0</i>	I-58
	8.2.5	<i>Distribution of axle loads</i>	I-58
	8.2.6	<i>Equivalent vertical loading for earthworks and earth pressure effects</i>	I-61
	8.2.7	<i>Footpaths and general maintenance loading</i>	I-61
	8.3	Dynamic magnification factors Φ (Φ_2 , Φ_3)	I-61
	8.3.1	<i>Definition of the dynamic factor Φ</i>	I-62
	8.4	Application of traffic loads on railway bridges	I-64
	8.5	Horizontal forces - characteristic values	I-65
	8.5.1	<i>Centrifugal forces</i>	I-65
	8.5.2	<i>Nosing force</i>	I-67
	8.5.3	<i>Actions due to traction and braking</i>	I-68
	8.6	Multicomponent actions	I-68
	8.6.1	<i>Characteristic values of multicomponent actions</i>	I-68
	8.6.2	<i>Other representative values of the multicomponent actions</i>	I-68
	8.7	Fatigue load models	I-69

	8.7.1 Assumption for fatigue actions	I-70
	8.7.2 The λ -factor design method	I-70
	8.7.3 Train types for fatigue	I-70
	REFERENCES	I-75
2	ACCIDENTAL ACTIONS ON BRIDGES (Pages II-1 to II-6)	
	Summary	II-1
1	INTRODUCTION	II-1
	1.1 General	II-1
	1.2 Background Documents	II-1
2	BASIS OF APPLICATIONS	II-2
3	LOADS DUE TO VEHICLE COLLISIONS	II-2
4	DESIGN EXAMPLES OF A BRIDGE PIER FOR COLLISION	II-3
5	DISCUSSION ON Annex C	II-4
6	REFERENCES	II-6
3	EN 1991-2, TRAFFIC LOADS ON BRIDGES: EXAMPLE OF CONCRETE BRIDGE DESIGN (Pages III-1 to III-15)	
	Summary	III-1
1	DESCRIPTION OF THE BRIDGE	III-1
	1.1 Geometric characteristics of a single longitudinal beam	III-1
2	DEFINITION OF LOADS	III-2
	2.1 Structural self weights	III-2
	2.2 Dead loads	III-3
	2.3 Traffic loads	III-4
	2.4 Wind action	III-5
	2.5 Thermal actions	III-8
3	CALCULATING THE STRESSES	III-8
	3.1 Distribution of the loads on the main beams	III-8
	3.2 Calculating the maximum stresses on the main beams	III12
4	EN 1991-2, TRAFFIC LOADS ON BRIDGES: EXAMPLE OF A STEEL BRIDGE DESIGN (Pages IV-1 to IV-17)	
	Summary	IV-1
1	DESCRIPTION OF THE BRIDGE	IV-1
	1.1 Geometric characteristics of the structure	IV-1
2	DEFINITION OF LOADS	IV-2
	2.1 Structural self-weights	IV-2
	2.2 Dead loads	IV-2
	2.3 Traffic loads	IV-3
	2.4 Wind action	IV-5
	2.5 Thermal actions	IV-8
3	CALCULATING THE STRESSES	IV-9
	3.1 Behaviour of the structure	IV-9
	3.2 Local effects on the deck plate	IV-9
	3.3 Calculation methods for the orthotropic deck	IV-10
	3.4 Calculating the main structure	IV-11

	3.4.1 <i>The effects of self-weight and dead load</i>	IV-11
	3.4.2 <i>The effects of traffic loads</i>	IV-12
	3.4.3 <i>Wind effects</i>	IV-14
	3.4.4 <i>Effects of thermal variations</i>	IV-14
	3.5 Calculating the transverse section	IV-15
5	EXAMPLE OF STEEL FOOTBRIDGE (Pages V-1 to V-10)	
	Summary	V-1
1	INTRODUCTION	V-1
	1.1 Background materials	V-1
2	DEFINITION OF THE SYSTEM	V-1
	2.1 The structural system	V-1
	2.2 Properties of the sections	V-2
3	DEFINITION OF THE ACTIONS	V-3
	3.1 Permanent actions	V-3
	3.1.1 <i>Self weight of structural members</i>	V-3
	3.1.2 <i>Deck cover</i>	V-4
	3.2 Snow loads	V-4
	3.3 Wind loads	V-5
	3.4 Thermal loads	V-7
	3.5 Traffic loads	V-7
4	COMBINATION OF ACTIONS	V-8
	4.1 Combination of action for the ultimate limit state verification	V-9
	4.2 Combination of actions for the serviceability limit state verification	V-10
5	REFERENCES	V-10
6	EXAMPLE OF A COMPOSITE BRIDGE (Pages VI-1 to VI-21)	
1	INTRODUCTION	VI-1
2	DEFINITION OF THE SYSTEM	VI-1
	2.1 Details of the system	VI-1
	2.2 Load History	VI-2
	2.3 Properties of the Section	VI-3
	2.3.1 <i>Bending Capacities</i>	VI-3
	2.3.2 <i>Moments of Inertia</i>	VI-3
	2.4 Resistance of the Transversal Girder and of the Stiffeners	VI-3
3	DEFINITION OF LOADS	VI-4
	3.1.1 <i>Permanent Loads Acting on the Structural Steel</i>	VI-4
	3.1.2 <i>Permanent Loads Acting on the Composite Beam</i>	VI-4
	3.2 Traffic Loads	VI-4
	3.3 Actions on Footways	VI-6
	3.4 Wind Loads	VI-7
	3.4.1 <i>Determination of the Relevant Gust Wind Pressure</i>	VI-7
	3.4.2 <i>Horizontal Wind Forces</i>	VI-7
	3.4.3 <i>Vertical Wind Forces</i>	VI-8
	3.5 Thermal Actions	VI-9
	3.6 Effects due to Shrinkage	VI-9
	3.7 Temporary Loads during Construction	VI-9
4	CALCULATION OF INTERNAL FORCES	VI-9

BRIDGES – ACTIONS AND LOAD COMBINATIONS

Pietro CROCE, Luca SANPAOLESI

Department of Structural Engineering, University of Pisa

1 FOREWORD

During the past years, traffic load models adopted in codes of practice for designing bridge structures have noticeably evolved.

In modern codes, static models adopted previously, representing physically existing heavy vehicles, have been replaced by ideal models, aimed to reproduce the target values of the effects induced in the bridges by the real traffic, i.e. the effects having given assigned return periods. At the same time, as progress in conception and design makes bridges very demanding in terms of with regard to fatigue performance, sophisticated fatigue load models have been recently introduced, to refine fatigue assessment.

The adoption of such refined models gives so much flexibility, that it is necessary to outline very carefully the models themselves and the calibration carried out for their development, in order to arrive at coherent schemes having univocal interpretation.

Amongst the most recent models, particularly remarkable are the traffic load models of the EN1991_2 (Eurocode 1, Actions on Structures Part 2): Traffic loads on bridges [1], and these models are illustrated and discussed in the Handbook.

In the present handbook, actions on bridges and load combinations according to Eurocode 1_2 are illustrated, stressing the philosophy and methodological criteria that have brought to the definition of relevant static and fatigue traffic load models for road, pedestrian and railway bridges.

Due to its peculiarities, road bridges are illustrated in much more details, so that, starting from real traffic data measurements, the derivation of the load models are illustrated step by step, emphasising the peculiarities of the calibration methods adopted in pre-normative research as well as relevant questions not fully covered in the code.

2 DEVELOPMENT OF THE STATIC ROAD TRAFFIC LOAD MODELS OF EC1.2

Static load models of EN 1991-2 have been developed so that static traffic load models satisfy the following modern criteria

- should be easy to use;
- should be applicable independently on the static scheme and on the span length of the bridge;
- should be able to reproduce as accurately as possible the target values, covering all the possible scenarios of flowing traffic and traffic jams, that can occur during the design life of the bridge;

- should include in the load values dynamic magnifications due to the road-vehicle and to the bridge-vehicle interactions;
- should allow to easily combine local and global effects of actions;
- should be unambiguous, covering all the cases that could occur in the design practice.

Obviously as, the load models were defined and calibrated referring to traffic induced effects having assigned return period, the normative studies required to deal with complicated theoretical and methodological problems. Among these, specially significant were the problems concerned with the extrapolation on very long time periods of the effects determined using flowing traffic data recorded on one lane for few days or few weeks, and taking into account at the same time the most severe flowing and/or congested traffic scenarios that could happen on one or on several lanes.

2.1 Static load model philosophy

As a rule, the evaluation of target values of real traffic induced effects and subsequent drafting and calibration of the load model can be carried out by analytical and numerical methodologies using in order of succession the following steps:

- identification of the most significant real traffic measurements;
- choice of the static schemes and spans of the relevant bridges;
- choice of the influence surfaces the most significant effects;
- elaboration of the traffic data and their manipulation to obtain jammed, slowed down and flowing traffic types;
- determination of the histograms of the extreme values of the effects induced by the transit of the different traffic typologies on the considered influence surfaces;
- simulation of extreme scenarios for multilane traffic;
- elaboration and extrapolation of the histograms of the extreme values of the effects to evaluate their target values , characterized by assigned return period;
- correction of the target values to take into account the dynamic effects due to road-vehicle and to vehicle-structure interactions;
- drafting and calibration of the load model;
- applicative trials;
- model refinement.

2.2 Statistical analysis of European traffic data

The first phase of the study regarded the statistic analysis of European traffic data, in order to select the most representative ones, in terms of the expected flow and composition trends.

The available registrations of European traffics were mainly the result of two large measurement campaigns performed, respectively, between 1977 and 1982 on bridges situated in France, Germany, Great Britain, Italy and Holland and between 1984 and 1988 on several roads all around the Europe. Recorded daily flows on the slow lane were varying between 1000 and 8000 lorries on motorways, and between 600 and 1500 lorries on main roads, while fast lane daily flows on motorway and slow lane daily flows on secondary roads resulted drastically reduce to

100-200 lorries. (Croce & Sanpaolesi 1991, Croce & al 1991).

Statistical analyses, that allowed to know the distributions of the most significant traffic parameters, like traffic composition, inter-vehicle distances, inter-axles, weight, length and speed of each lorry, essentially concerned data recorded in Italy, France and Germany: the data from England appeared poorly representative of the continental situation, while those Spanish and Dutch data seemed excessively influenced by the peculiarities of the respective road systems.

Significantly important data, concerning long distance motorway traffics recorded in Auxerre (F), Garonor (F), Brohltal (D), Fiano Romano (I), Sasso Marconi (I) and Piacenza (I), are shown in the following tables and figures.

Table 1 shows the daily flows of cars and lorries per lane and the percentage of inter-vehicular distances smaller than 100 meters; table 2 illustrates the traffic compositions in terms of standardized lorries, while table 3 illustrates the composition of the whole fleets of circulating commercial vehicles in the three above mentioned Countries. The daily flows of axles heavier than 10 kN, and lorries together with the relating statistical parameters are shown in table 4 and 5, respectively.

	<i>Cars</i>	<i>Lorries</i>	<i>% intervehicle distance < 100 m</i>
<i>Brohltal (D)</i>	11126	4793	26.7
<i>Garonor (F – 1982)</i>	--	2570	32.6
<i>Garonor (F – 1984)</i>	--	3686	32.3
<i>Auxerre (slow lane) (F)</i>	8158	2630	18
<i>Auxerre (slow lane) (F)</i>	1664	153	8.5
<i>Fiano R. (I)</i>	8500	4000	26.1
<i>Piacenza (I)</i>	8500	5000	30.9
<i>Sasso M. (I)</i>	7500	3500	24.3

Table 1. Daily traffic flows per lane

	Lorries (%) (2 Axles)	Lorries (%) (>2 Axles)	Articulated lorries (%)	Lorries with trailer (%)
<i>Brohltal (D)</i>	16.6	1.6	40.2	41.6
<i>Garonor (F - 1982)</i>	38.6	2.6	47.6	11.2
<i>Garonor (F - 1984)</i>	47.5	2.2	44.3	6.0
<i>Auxerre (slow lane) (F)</i>	22.7	1.3	65.2	10.8
<i>Auxerre (fast lane) (F)</i>	27.6	3.5	58.4	10.5
<i>Fiano R. (I)</i>	41.4	7.0	29.0	22.6
<i>Piacenza (I)</i>	35.3	7.5	35.8	21.4
<i>Sasso M. (I)</i>	40.1	10.0	30.2	19.7

Table 2. Composition of the commercial traffic

Generally, the analysis of the European traffic data shows that the mean values of axle-loads and total weight of heavy vehicles are strongly dependent on the traffic typology, i.e. on the road classification, and they are generally very scattered:

- the statistical distribution of the axle-load is generally unimodal, with the mode of about 60 kN, while the statistical distribution of the total weight is bimodal with the first mode of about 150 kN and the second mode of about 400 kN;
- on the contrary, the daily maximum values are much less sensitive to the traffic typology and they vary between 130 and 210 kN for single axles, between 240 and 340 kN for two axles in tandem, between 220 and 390 kN for three axles in tridem, and between 400 and 650 kN for the total weight;
- the daily maximum of the axle-loads as well as the daily maximum of total weight of the vehicle largely exceed the values legally admitted;
- in consequence of the choices of the lorry manufactureres, vehicle geometries have remained practically the same since the 1980's: the inter-axle distance distribution strongly results trimodal: the first mode, a little scattered, is located around 1.30 m and it corresponds to the usual inter-axle for tandem and tridem axles, the second mode, also it characterized by modest scattering, is located around 3.20 m and it is typical of the tractors of articulated lorries, while the third one, located around 5.40 m, is much more dispersed;
- long distance continental Europe traffic data result in homogeneous enough data;
- the heavy traffic composition evolved in a very straightforward way during the 1980's: the percentage of articulated lorries stepped up despite a strong reduction in the less commercially profitable trailer trucks, , in conjunction with a contraction of the number of single lorries, whose use is limited increasingly to local routes;
- in consequence of a better and more rational management of the lorry fleets, the number of empty lorry passages has been reduced or limited, in case of articulated lorries to the tractor unit only, so raising the mean vehicle loads;
- the long distance traffics are much more aggressive than local traffics;

- generally the lorry flows are tending to increase, (N.B. In the studies the absolute maximum (8600 lorries per day on the slow lane) was recorded in 1980 in Germany on the Limburger Bahn).

On the basis of the above mentioned considerations, for the model calibration purposes it was decided to select, as homogenous reference traffic those recorded in France, on the motorway A6 near Auxerre. The Auxerre traffic is very severe and summarizes effectively the main characteristics of the long distance European traffic, especially in terms of composition. The other traffic data have been used only for checking the reliability of the results obtained in Auxerre.

	<i>Germany</i>	<i>France</i>	<i>Italy</i>
<i>2 axles</i>	17.0	32.0	38.67
<i>3 axles</i>	5.0	5.8	9.0
<i>4 axles</i>	25.0	25.0	10.0
<i>5 axles</i>	52.0	33.2	33.0
<i>6 axles</i>	1.0	4.0	8.0
<i>> 6 axles</i>	--	--	1.33

Table 3. Composition of the circulating lorry fleets

	<i>ALL AXLES</i>				<i>TANDEM AXLES</i>				<i>TRIDEM AXLES</i>			
	<i>Flow</i>	<i>P_{mean} [kN]</i>	<i>σ [kN]</i>	<i>P_{max} [kN]</i>	<i>Flow</i>	<i>P_{mean} [kN]</i>	<i>σ [kN]</i>	<i>P_{max} [kN]</i>	<i>Flow</i>	<i>P_{mean} [kN]</i>	<i>σ [kN]</i>	<i>P_{max} [kN]</i>
<i>Brohltal (D)</i>	19970	59.0	28.4	165.0	1977	116.5	54.6	260.0	1035	60.0	230.0	355.0
<i>Garonor (F) 1982</i>	8470	57.6	27.6	180.0	712	126.3	49.3	340.0	303	90.0	200.0	295.0
<i>Garonor (F) 1984</i>	11593	59.3	30.0	195.0	1016	132.1	58.1	290.0	489	90.0	200.0	320.0
<i>Auxerre (F) slow lane</i>	10442	82.5	35.2	195.0	844	165.6	54.0	305.0	961	130.0	250.0	390.0
<i>Auxerre (F) fast lane</i>	581	73.1	41.2	200.0	47	141.2	63.9	275.0	51	120.0	250.0	390.0
<i>Fiano R. (I)</i>	15000	56.8	32.9	142.0	2000	115.2	45.5	245.0	900	80.0	260.0	360.0
<i>Piacenza (I)</i>	20000	61.8	31.0	135.0	2500	127.0	44.1	260.0	1500	100.0	220.0	365.0
<i>Sasso M. (I)</i>	13000	61.9	30.8	135.0	1600	136.4	49.5	260.0	800	110.0	250.0	375.0

Table 4. Daily flows and statistical parameters of axles heavier than 10 kN and lorries

	<i>Flow</i>	P_{mean} [kN]	σ [kN]	P_{max} [kN]
<i>Brohltal (D)</i>	4793	245.8	127.3	650.0
<i>Garonor (F) 1982</i>	2570	189.8	107.5	550.0
<i>Garonor (F) 1984</i>	3686	186.5	118.0	560.0
<i>Auxerre (F) slow lane</i>	2630	326.7	144.9	630.0
<i>Auxerre (F) fast lane</i>	153	277.2	163.6	670.0
<i>Fiano R. (I)</i>	4000	204.5	130.3	590.0
<i>Piacenza (I)</i>	5000	235.2	140.0	630.0
<i>Sasso M. (I)</i>	3500	224.9	149.0	620.0

Table 5. Daily flow and total weights of commercial vehicles

The most relevant parameters of the slow lane Auxerre traffic are summarized in the figures 1 to 6: more precisely, the histograms of vehicle speeds, inter-vehicle distances and axle loads referring to the whole of the flow are reported in figures 1, 2 and 3, respectively, while the analogous histograms referring only to the lorry flow are reported in figures 4, 5 and 6.

From the statistical analyses a relevant conclusion can be derived: speed and length of vehicles are poorly correlated and practically independent, from the probabilistic point of view, on the axle-loads and on the total weight of the vehicles.

It must be stressed, finally, that European traffics exist, which are more aggressive than the Auxerre traffic, like that recorded in Paris on the Boulevard Périphérique. Such traffics, nevertheless, are not very significant, since they depend on local situations, and are hard to generalize.

2.3 Traffic scenarios

The evaluation of the target values of the effects induced on the bridge by the recorded reference traffic is not trivial: in fact, since traffic recordings generally refer to normal situations of flowing traffic, they are often inadequate to represent the most severe situations, which can happen in disturbed traffic condition. For this reason, in order to consider extreme traffic situations as well, traffic data have opportunely been manipulated, considering deterministic traffic scenarios, representative of some relevant real situation (Croce & al. 1991, Bruls & al. 1996.a, Bruls & al. 1996.b, Croce & al. 1997).

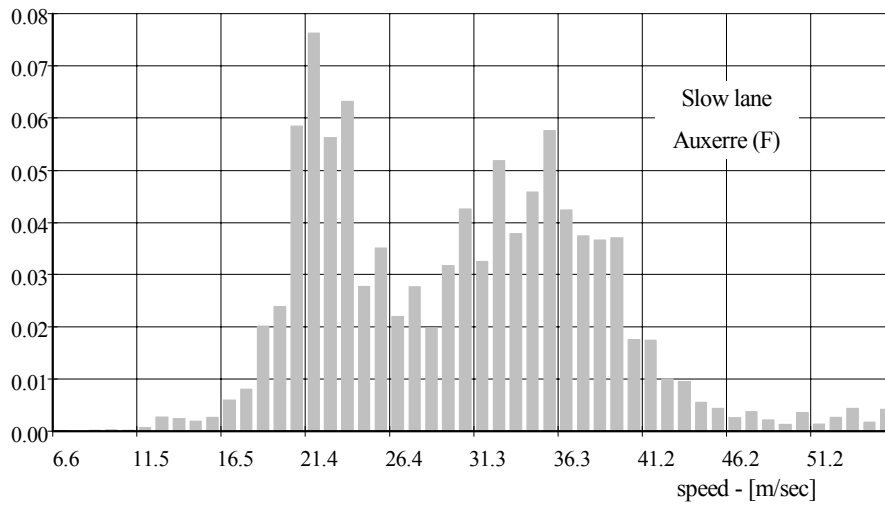


Fig. 1. Histogram of the vehicle speed frequency – Auxerre – whole of the flow

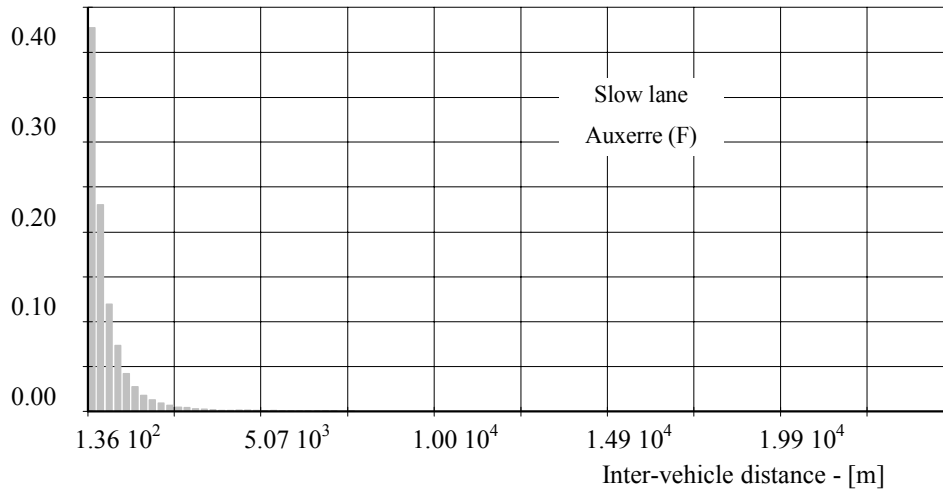


Fig. 2. Histogram of the inter-vehicle distance frequency – Auxerre – whole of the flow

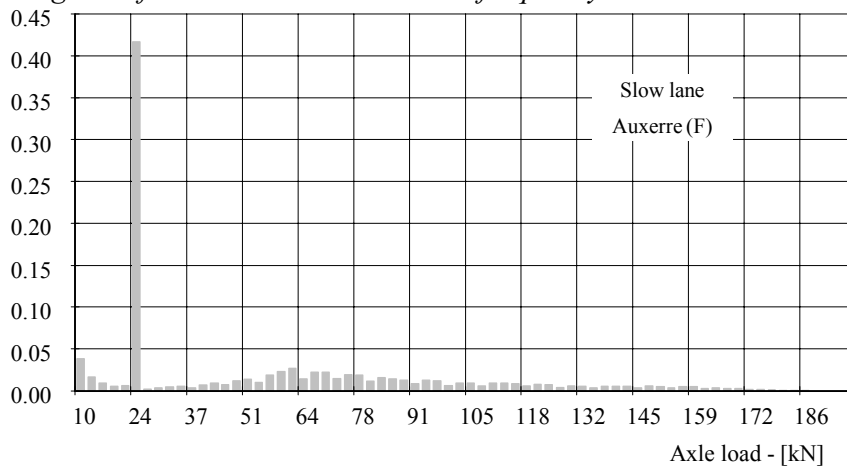


Fig. 3. Histogram of the axle load frequency – Auxerre – whole of the flow

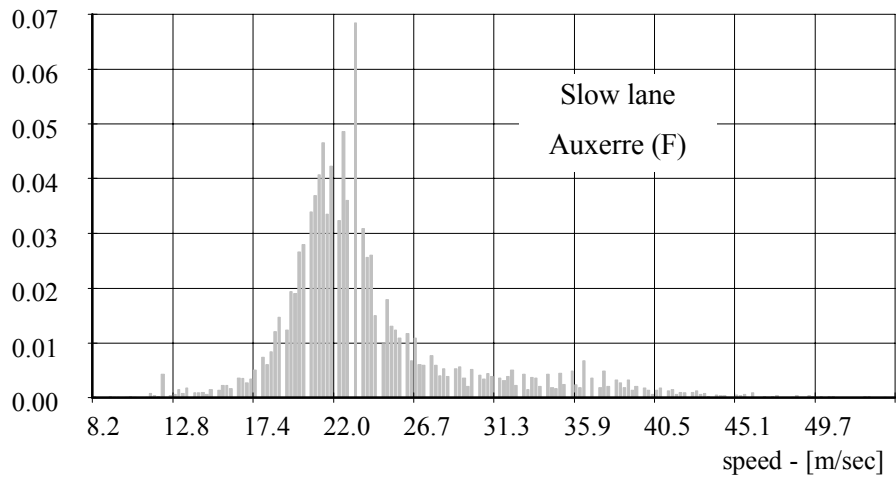


Fig. 4. Histogram of the vehicle speed frequency – Auxerre – lorries

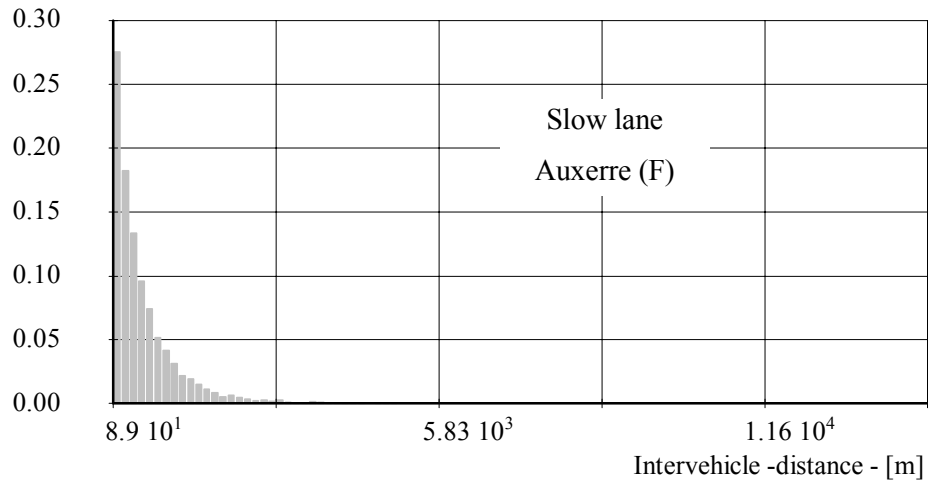


Fig. 5. Histogram of the inter-vehicle distance frequency – Auxerre – lorries

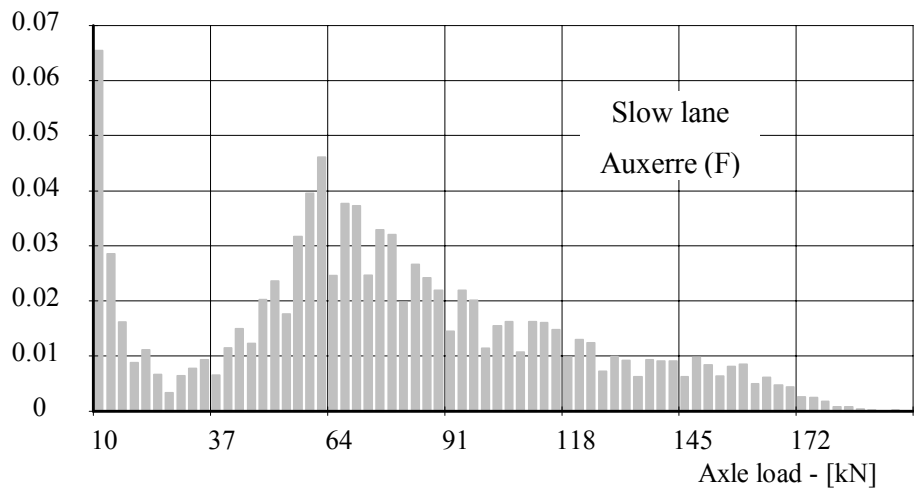


Fig. 6. Histogram of the axle load frequency – Auxerre – lorries

Concerning the single lane, four different types of traffic models have been developed as follow: *flowing*, *slowed down*, and *congested* with/or without cars.

The *flowing* traffic, to which a suitable dynamic coefficient must be associated, is represented by the traffic as recorded. Flowing traffic is particularly important in bridges spanning up to 30 to 40 m to evaluate characteristic values of the effects, or in a much wider field to determine frequent values of the effects.

Slowed down traffic is significant when infrequent loads are to be defined. It can be easily obtained considering the vehicles in the recorded order and reducing the distance among the adjacent axles of two consecutive vehicles to a suitable value, generally assumed equal to 20 m, so simulating vehicle convoys in the phase of braking.

The *congested* traffic, which is relevant when the bridge span is greater than 50 m, can be finally extracted from the recorded ones reducing to 5 m the distance between the adjacent axles of two consecutive vehicles, in such a way that a traffic column in slow motion is reproduced. Since the traffic scenarios are particularly influenced by the driver behaviours: among the congested traffic configurations it is particularly meaningful that one characterized by the presence on the slow lane of lorries only, that is caused by the tendency of the drivers of lighter and faster vehicles to change lane to overtake, when the traffic slows down. This is very well represented in classical photos, like that reported by Tschemmenerg & al. 1989, relative to traffic jams on the Europa bridge (fig. 7). Obviously, the congested traffic without cars is obtained eliminating from the recordings all the light vehicles.

In the numerical simulations devoted to the definition of the target values in the framework of Eurocode studies, the extreme situations characterised by flowing or jammed traffic on one or several lanes have been modeled considering several deterministic traffic scenarios. Through starting from numerous, complex and diversified hypotheses synthesized below, the different traffic scenarios bring to comparable results, so that all and sundry have been taken into account in calibrating the load model.

For *flowing* multilane traffic a combination of the following effects were considered:

- for the most loaded lane, the first lane, the extrapolated effect induced by the slow lane Auxerre traffic as recorded;
- for the second lane, the daily maximum effect, i.e. extrapolated not, induced by the slow lane Auxerre traffic as recorded;
- for the third lane, the mean daily effect induced by the slow lane Auxerre traffic as recorded;
- for the fourth lane, the mean daily effect induced by the fast lane Auxerre traffic as recorded.

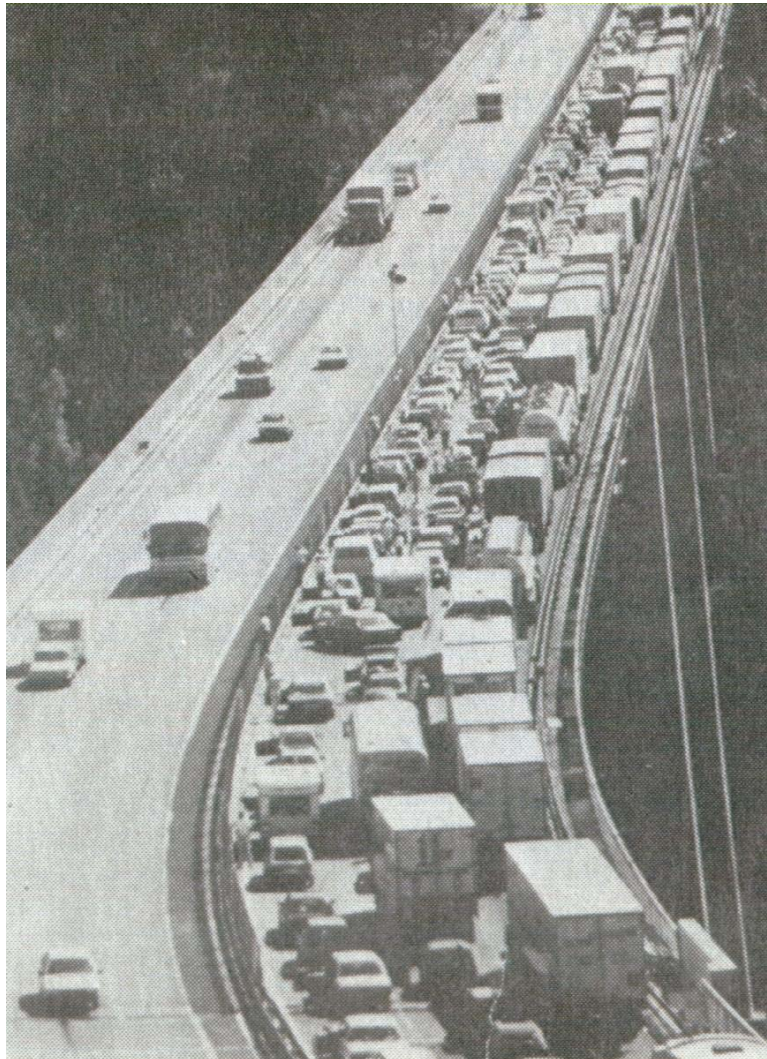


Fig. 7. Traffic jam on the Europa Bridge (from Tschemmerneegg & al. 1989)

The *jammed* traffic scenarios took into account:

- for the most loaded lane, the first lane, the extrapolated effect induced by the congested traffic without cars, deduced from that of the Auxerre slow lane;
- for the second lane, the daily maximum effect induced by the congested traffic with cars, deduced from that of the Auxerre slow lane;
- for the third lane the daily maximum effect induced by the slow lane Auxerre traffic as recorded;
- for the fourth lane the mean daily effect induced by the slow lane Auxerre traffic as recorded.

Target values have then been evaluated referring to a big number of bridge spans and influence surfaces. In particular, nine cylindrical influence surfaces have been considered for simply supported as well as continuous bridges, whose spans varied between 5 and 200 m.

2.4 Extrapolation methods

As mentioned above, the choice of the main load model and its calibration needs the taking account of the preliminary knowledge of the relevant values of the effects, i.e. characteristic, infrequent, frequent, quasi-permanent values, that the real traffic induces in the bridges, that must be reproduced by the load model itself.

Even considering deterministic traffic scenarios, the methodology to evaluate the target values cannot be taken for granted.

The numerical procedures usually employed to appraise the values of the effects characterized by an assigned return period are generally based on suitable extrapolation methods of the histograms of the traffic induced effects.

The relationship between the return period and the distribution fractile can easily be determined. When the heavy vehicles flow on the bridge is presumed uniform, the distance among two vehicles can be considered as equivalent to the unit time interval, so that the vehicles are described by a stationary time series $X_1, X_2, \dots, X_i, \dots, X_n$, being X_i the weight of the i -th vehicle, that enters the bridge at time i . If the X_i are independent and distributed according to the same cumulative distribution function $F(x)$, the return period R_x of the x value of X_i , defined as

$$R_x = E[N_x], \text{ where } N_x = \inf\{n \mid X_1 < x, X_2 < x, \dots, X_{n-1} < x, X_n \geq x\}, \quad (1)$$

it results

$$R_x = [1 - F(x)]^{-1}. \quad (2)$$

If the time series is replaced by a stationary stochastic process $\{X_t, t > 0\}$, then

$$R_x = E[T_x], \text{ where } T_x = \inf\{t \mid X_t \geq x \wedge X_u < x, \forall u < t\}. \quad (3)$$

If Y_N is the maximum value of X_i and N is the total flow of vehicles during the reference period, then it is

$$Y_N = \max\{X_i, 0 < i \leq N\}, \quad (4)$$

while the cumulative function of distribution $F[Y_N]$ of Y_N itself, since the X_i are independent and identically distributed, is given by

$$F[Y_N] = [F(x)]^n. \quad (5)$$

In conclusion, y_α the upper- α fractile of Y_N ,

$$\alpha = 1 - F(y_\alpha), \quad (6)$$

results, for $N \rightarrow \infty$ and $T \rightarrow \infty$,

$$R = R_{y_\alpha} = -\frac{T}{\ln(1 - \alpha)} \cong \frac{T}{\alpha}, \text{ in which } 0 < \alpha \ll 1. \quad (7)$$

The expression (7), that is independent of y_α and of the distribution of X , allows it to relate the return period to the fractile. For example, when the design life is 50 year, the 5% fractile ($\alpha=0.05$) match the value having a return period $R=974.78 \approx 1000$ years.

In general, to evaluate the extreme values of the effects induced by the traffic, three different

methods of extrapolation have been employed, using the half-normal distribution, the Gumbel distribution and the Montecarlo method, respectively. It is important to stress, that the target values are practically independent on the extrapolation method.

2.4.1 Half-normal distribution extrapolation method

The extrapolation method based on the half-normal distribution, hypothesises that the upper tail, of the extreme values distribution of the stochastic variable X can be approximated by a normal distribution through an opportune choice of the two curve parameters.

The value x_R , having a return period R, is given then by

$$x_R = x_0 + \sigma \cdot Z_R, \quad (8)$$

where x_0 is the last mode of the distribution and Z_R is the upper α -fractile of the standardised normal variable Z,

$$\alpha = (2 \cdot N)^{-1}, \quad (9)$$

being N the total flow during the reference period R.

2.4.2 Gumbel distribution extrapolation method

Under hypotheses similar to those illustrated in the previous paragraph, the extreme values distribution can be represented through the two parameters type I extreme values distribution, Gumbel distribution.

The parameters u and α' , which represent, respectively, the mode and the scattering of the distribution, can be derived from the extreme values histogram as

$$u = m - 0.45 \cdot \sigma, \quad \alpha' = (0.7797 \cdot \sigma)^{-1}, \quad (10)$$

where m and σ are the mean value and the standard deviation of the histogram. The value x_R results then

$$x_R = u + y \cdot \alpha', \quad (11)$$

being

$$y = -\ln[-\ln(1-R)^{-1}], \quad (12)$$

the reduced variable of the distribution.

An example of application of this extrapolation method on a Gumbel chart for a generic effect $T(y)$ is synthetically illustrated in figure 8.

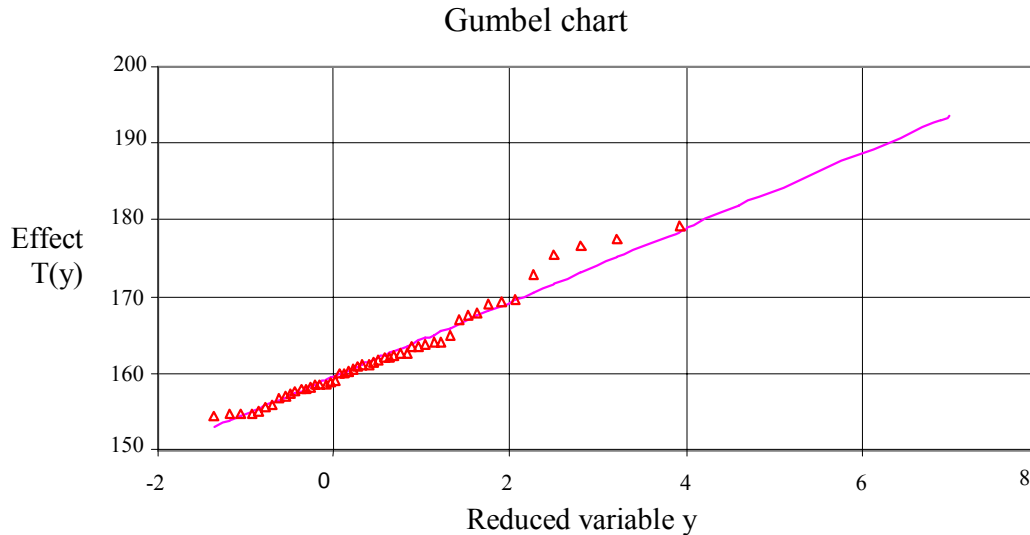


Fig. 8. Data extrapolation on the Gumbel chart

2.4.3 Montecarlo method extrapolation

The numerical extrapolation procedures based on the Montecarlo method make use of automatic generation, starting from the recorded traffic, of a suitable set of extreme traffic situations, in such a way that a suitable population of extreme values is obtained, to be elaborated with an appropriate extrapolation method.

The population can be produced in several ways.

The simplest and intuitive procedure consists in the repeated application of the Montecarlo method. The vehicles crossing the bridge are randomly selected amongst a complete set of standard vehicles, representing the most common real lorries. The lorry types, the axle loads, the inter-axes distances and the inter-vehicle distances are generated accordingly the relevant statistic parameters of the recorded traffic.

An alternative procedure more complicated but also much more effective, has been proposed and adopted by Croce for calibrating the target values. In this methodology the Montecarlo method is employed to obtain, starting from the statistical parameters of the extreme values distribution induced from recorded traffic, representative statistics of the effects, which constitute the input data for the calculation of the statistical parameters of the Gumbel distribution.

This latter method, allowed also to underline that target values, are poorly dependent upon the traffic jam frequency, at least for the most loaded lane.

2.5 Definition of dynamic magnification factors

In addition to the extrapolated static effects, the target values evaluation requires also specific knowledge about the dynamic effects, due to vehicle-bridge interactions, to be considered in

calibration studies regarding ultimate limit states, serviceability limit states and fatigue assessment (Sedlacek & al. 1991).

2.5.1 *The inherent impact factors*

Since the recorded traffic data refer to flowing traffic, they contain some dynamic effects too, and so they must be corrected through the so-called inherent impact factor.

The inherent impact factor, which is intrinsic in the measurements, can be evaluated simulating numerically the measures.

For the purposes EN 1991-2, the Auxerre weighing in motion device has been simulated considering the lorries, represented by a sequence of axles with shock-absorbers having suitable dynamic characteristics, running on good roughness pavement resting on rigid foundation. In this way it was stated that the characteristic values, which are relevant for the ultimate limit states, are affected from an inherent impact factor $\phi_i=1.10$, while static and dynamic effects practically coincide - $\phi_i=1.00$ - when serviceability limit states and fatigue are considered, i.e. in the range between the 10% and the 90% fractiles.

2.5.2 *The impact factors*

The impact factor depends on the several parameters, like type, static scheme and span of the bridge, the natural frequency, the damping coefficient, the dynamic characteristics and the speed of the lorries, the roughness of the road pavement etc.. Generally, its results are greater when the natural frequency of the bridge is close to the natural frequencies of axles (10÷12 Hz) and lorries (1÷2 Hz).

In the EN 1991-2 framework several numerical simulations have been performed on several bridge schemes with varying traffic scenarios in order to determine global local impact factors. In studying global dynamic effects medium or good road pavement roughness has been considered, while in studying local dynamic effects a stepped irregularity, 30 mm height and 500 mm wide, simulating a road surface discontinuity, due to damaged expansion joint, pothole or ice sheet. The result of each numerical simulation is an oscillogram of the considered effect, see figure 9, through which it is possible to define the so-called physical impact factor ϕ , defined as the ratio between the maximum dynamic response and the maximum static response of the bridge

$$\phi = \frac{\max_{\text{dyn}}}{\max_{\text{st}}} \quad (13)$$

This physical impact factor refers to a well precise load configuration and it depends on such a quantity of parameters that cannot be directly employed for load model calibration. Besides, ϕ greatly reduces for the heaviest vehicles, influencing the extreme values of the dynamic distribution and then the target values.

In any case, for calibration purposes, the dynamic effects can directly be considered, referring to the dynamic effects distribution, or, in an alternative way, multiplying the static effect distribution by a suitable calibration value of the impact factor, ϕ_{cal} , defined as the ratio between the dynamic value $E_{(\text{dyn},x\text{-fractile})}$ and the static value $E_{(\text{st},x\text{-fractile})}$ corresponding to the same assigned x-fractile

$$\varphi_{cal} = \frac{E_{dyn(x-fractile)}}{E_{st(x-fractile)}} \quad (14)$$

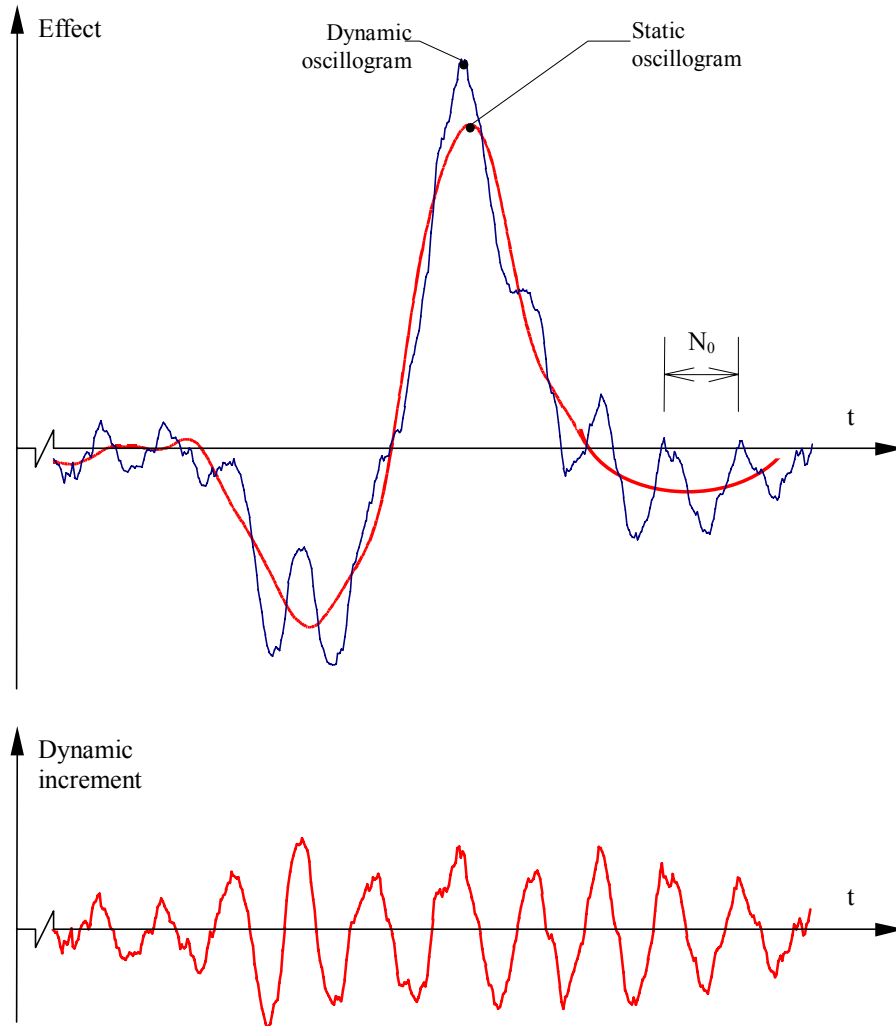


Fig. 9. Definition of the physical impact factor

Logically, due to its conventional nature, φ_{cal} doesn't have a precise physical meaning; in fact the static and dynamic x-fractiles don't correspond to the same load configuration.

The characteristic values of the calibration impact factors φ_{cal} , derived from Auxerre traffic and employed in EN1991-2, are synthesized in figure 10, depending on the span length L.

The knowledge of φ_{cal} values finally enables to determine the target dynamic values $E_{dyn(x-fractile)}$, through the expression

$$E_{dyn(x-fractile)} = \frac{\varphi_{cal} \cdot \varphi_{local}}{\varphi_i} \cdot E_{st(x-fractile)} \quad (15)$$

where φ_{local} represents the local impact factor, when relevant.

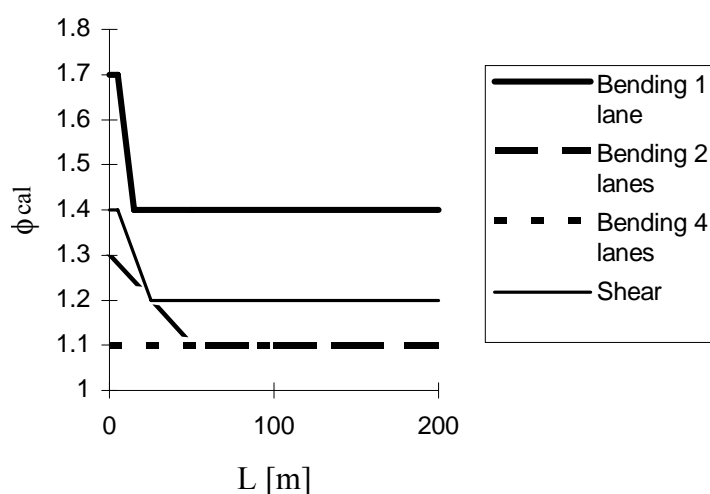


Fig. 10. Calibration value of the impact factors φ_{cal} (EC1).

2.6 Setup and calibration of the EN 1991-2 traffic load models

Reflecting the model philosophy described above, the definition and the calibration of the traffic load model of EN 1991-2 has been carried out step by step, and adapting the demands for accuracy with for ease of use. As underlined by preliminary calibrations, the best approximation of the target values was allowed by load models so characterized: a related presence of concentrated and distributed loads; two concentrated loads in each relevant lane, since a bigger number of concentrated loads doesn't affect the precision of the results; intensity of the uniformly distributed load decreasing function of the loaded length L .

The preliminary solution has been successively modified to simplify the structure and the application rules of the load model, mainly to eliminate any reason for ambiguity, finally arriving to a load model typified by:

- load values independent from the loaded length;
- load values just including the dynamic effects;
- related presence between concentrated and distributed loads;
- aptness for the evaluation of local and global, even simultaneous, effects;
- width of the notional lane equal to 3.0 m.

For the sake of model coherence, it has been established that, when relevant, the whole carriageway width can be loaded, i.e. not only the part occupied by the notional lanes, but also that one remaining.

In order to cover the target values of local effects in secondary elements, characterized by influence surfaces with very small base length, it has been also introduced a local load model, constituted by a single axle, which is alone on the bridge.

The load model defined above, opportunely calibrated, constitutes the load model of EC1 – part 2, illustrated more precisely in point 3.

2.7 Other representative traffic load values

Besides characteristic loads, having 1000 years return period, also infrequent, frequent and quasi-permanent values of traffic loads have been considered, which are particularly relevant for SLS assessments.

Infrequent and frequent values have been identified by one year or one week return period, respectively. Quasi-permanent values, which result generally in negligible values, except for particular cases, like, for example, bridges in the urban zone, were set to zero.

The studies regarding frequent and infrequent values of the effects induced by the real traffic were substantially analogous to those performed for characteristic values, so their detailed illustration is omitted here, and only some particularly significant results are pointed out:

- the ratio between infrequent and characteristic traffic load values is about 0.9, which means that the characteristic value is a little influenced by the choice of the return period;
- the ratio between infrequent and characteristic traffic load values can be reduced to 0.8, if the infrequent load values are evaluated considering, rather than a medium roadway roughness, a good one;
- the ratio between frequent and characteristic traffic load values is equal to 0.7 to 0.8 for short span bridges;
- since the frequent value of the load depends only on the flowing traffic, the ratio between frequent and characteristic traffic load values tends to a minimum of 0.4 to 0.5 as the bridge span increases.

3 THE EN 1991-2 LOAD TRAFFIC MODELS

In the following the most significant characteristics of the traffic load models for road bridges of EC1 (EN1991-2), to which is referred for closer examinations, are illustrated.

The load model is applicable to all road bridges having carriageway width smaller than 42 m and loaded length less than 200 m.

3.1 Division of the carriageway and numbering of notional lanes

The carriageway is defined as the part of the roadway surface sustained by a single structure (deck, pier etc.): it includes all the physical lanes (marked on the roadway surface), the hard shoulders, the hard strips and marker strips. Its width w should be measured between the kerbs, if their height is greater than 100 mm, or between the inner limits of the safety barriers, in all other cases. The width does not include, in general, the distance between fixed safety barriers or kerbs of a central reservation nor the widths of these barriers.

The carriageway is divided in notional lanes, generally 3 m wide, and in a remaining area, according to table 6 and, for example, as shown in fig. 11. If the carriageway is physically divided in two parts by a central reservation, then:

- each part, including all hard shoulder or strips, should be separately divided in notional lanes, if the parts are separated by a fixed safety barrier;
- the whole carriageway, central reservation included, should be divided in notional lanes, if the parts are separated by demountable safety barriers or another road restraint system.

<i>Carriageway width w</i>	<i>Number of notional lanes n_l</i>	<i>Width of a notional lane</i>	<i>Width of the remaining area</i>
$w < 5.4 \text{ m}$	1	3 m	$w - 3 \text{ m}$
$5.4 \text{ m} \leq w < 6 \text{ m}$	2	$0.5 w$	0
$6 \text{ m} \leq w$	$\text{Int}(w/3)$	3 m	$w - 3 \times n_l$

Table 6. Subdivision of the carriageway

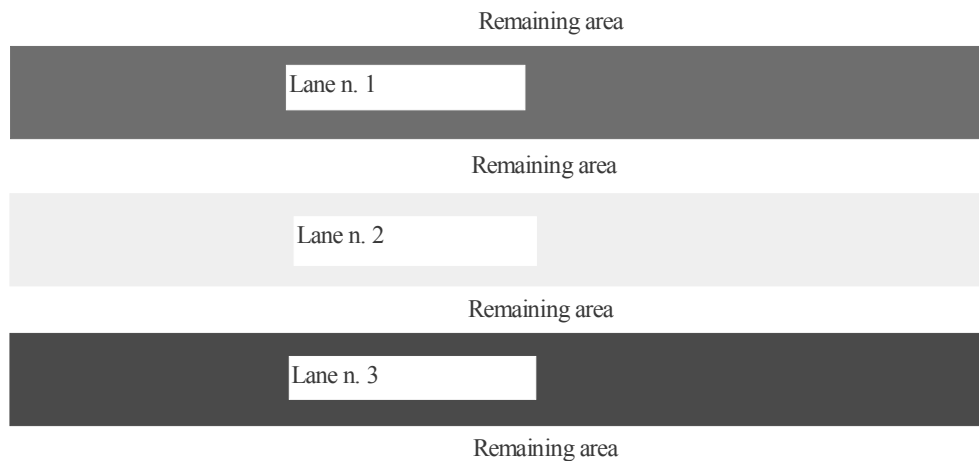


Fig. 11. Example of lane numbering

The location of the notional lanes is not linked with their numbering, so that number and location of the notional lanes are select each time in order to maximize the considered effect. In particular cases, for serviceability limit states or fatigue verifications, it is possible to derogate from this rule and to consider less severe locations of the notional lanes. In general, the notional lane that gives the most severe effect is numbered lane n. 1 and so on, in decreasing order of severity.

When the carriageway consists of two separate parts on the same deck, only one numbering should be used for the whole carriageway, considering, obviously, that lane n. 1 can be alternatively on the two parts (fig. 12). When, instead, carriageway consists of two separate parts on two independent decks, supported by the same abutments or the same piers, two cases are distinguished: for deck design purposes each part is considered and numbered independently, while, on the contrary, for abutment or pier design the two parts are considered and numbered together (fig. 13).

3.2 Load models for vertical loads

The load models representing vertical loads are intended for the determination of road traffic effects associated with ultimate limit state verifications and with particular serviceability verifications.

Four different load models are considered:

- load model n. 1 (LM1), composed by concentrated and uniformly distributed loads, which cover most of the effects of the traffic of lorries and cars, to be used for global and local verifications.
- load model n. 2 (LM2), composed by a single axle load on specific tire contact areas, which cover traffic effects on short structural members;
- load model n. 3 (LM3), special vehicles, representing abnormal vehicles not complying with national regulations on weight and dimension of vehicles; which should be considered only when requested in a transient design situation. The geometry and the axle loads of the special vehicles to be considered will be assigned by the bridge owner.
- load model n. 4 (LM4), a crowd loading.

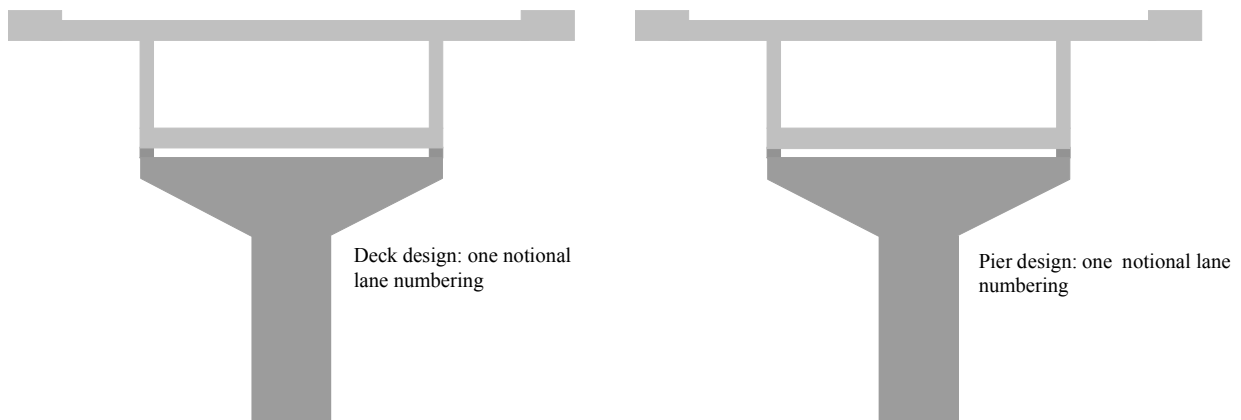


Fig. 12. Lane numbering – carriageway consisting of two separate parts on the same deck

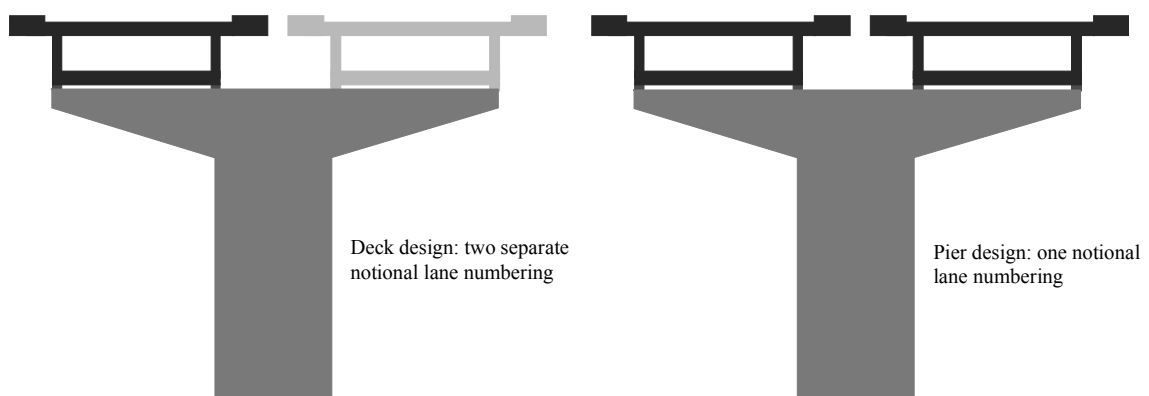


Fig. 13. Lane numbering – carriageway consisting of two separate parts on two separate decks

3.3 Load model n. 1

Load model n. 1 is constituted by two subsystems:

- a system of two concentrated axle loads representing a tandem system whose geometry is shown diagrammatically in fig. 14: each axle having weight $\alpha_Q \cdot Q_k$ (see table 7);
- a system of distributed loads having a weight density per square meter of $\alpha_q \cdot q_k$ (see table 7).

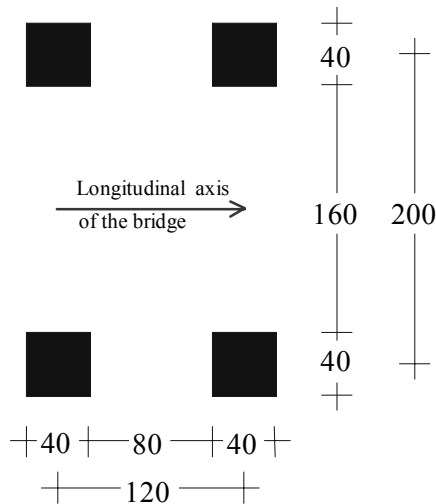


Fig. 14. Tandem system

Position	Tandem system – Axle load Q_{ik} [kN]	Uniformly distributed load q_{ik} [kN/m ²]
Notional lane n. 1	300	9.0
Notional lane n. 2	200	2.5
Notional lane n. 3	100	2.5
Other notional lanes	0	2.5
Remaining area	0	2.5

Table 7. Load model n. 1 – characteristic values

The adjustment factors α_Q and α_q depend on the class of the route and on the expected traffic type: in absence of specific indications, they are assumed equal to 1. The characteristic loads values on the notional i -th lane are indicated $\alpha_{Qi} \cdot Q_{ki}$ and $\alpha_{qi} \cdot q_{ki}$ while on the remaining area the weight density of the uniformly distributed load is expressed as $\alpha_{qr} \cdot q_{kr}$. For bridges without road signs restricting vehicle weights, should be assumed $\alpha_{Q1} \geq 0.8$ for the tandem system on the first notional lane, while for $i \geq 2$, $\alpha_{qi} \geq 1.0$ except for the remaining area.

The load model n. 1 should apply according to the following rules (see fig. 15):

- in each notional lane only one tandem system should be considered, situated in the most severe position;

- the tandem system travels in the direction of the longitudinal axis of the bridge, centrally along the axis of the notional lane;
- when present, the tandem system should be considered in full, i.e. with all its wheels;
- the uniformly distributed loads apply, longitudinally and transversally, only on the unfavorable part of the surface of influence;
- the two load systems can insist on the same area, so they are promiscuous;
- the impact factor is included in the load values $\alpha_{Q_i} \cdot Q_{ki}$ and $\alpha_{q_i} \cdot q_{ki}$;
- when the static verification is governed by combination of local and global effects, the same load arrangement should be considered;
- when relevant, and only for local verifications, the transverse distance between adjacent tandem system should be reduced up to a minimum of 40 cm.

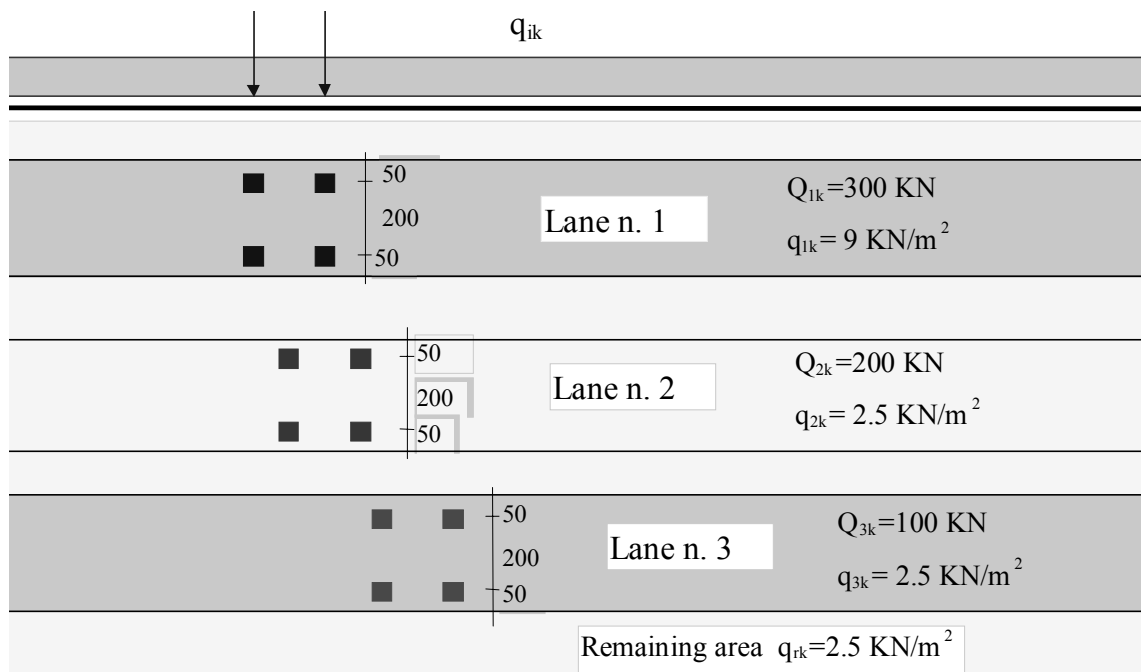


Fig. 15. Example of application of the load model n.1

3.4 Load model n. 2

The local load model n. 2, LM2, is a model constituted by a single axle load (fig. 16) $\beta_Q \cdot Q_{ak}$ with $Q_{ak} = 400 \text{ kN}$, dynamic amplification included. Unless otherwise specified β_Q should be taken equal to α_{Q1} . The load, which is intended only for local verifications, should be considered by itself on the bridge.

The model 2 is considered traveling in the direction of the longitudinal axis of the bridge, and should be applied in any location on the carriageway. If necessary, only one wheel load of $\beta_Q \cdot 200 \text{ kN}$ should be considered. The contact surfaces of the wheel, if not otherwise specified is a rectangle of sides $35 \times 60 \text{ cm}$.

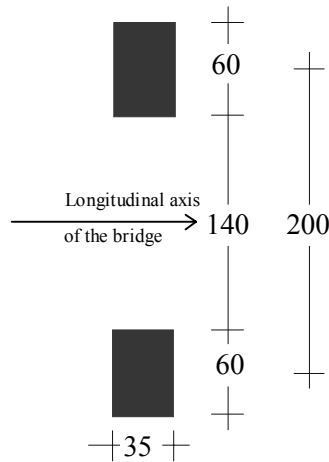


Fig. 16. Load model n. 2 (single axle)

3.5 Load model n. 3 - Special vehicles

Besides the above mentioned load models, the Eurocode also foresees a very conventional model, representing special vehicles, that can exceptionally transit on the bridges as abnormal vehicles. This load model is constituted by a set of standardized dispositions of axle loads, assigned by the bridge owner, and it should be considered only if expressly in demand. The application can obviously concern one or several special vehicles.

A set of standardized reference special lorries are reported in the informative Appendix A of EN 1991-2, according to table 8. The axle loads, whose values should be intended as nominal, are associated exclusively to transient design situations. Each axle load is considered uniformly distributed over two or three lengthen rectangular surfaces, depending on the axle weight, as illustrated in figure 17.

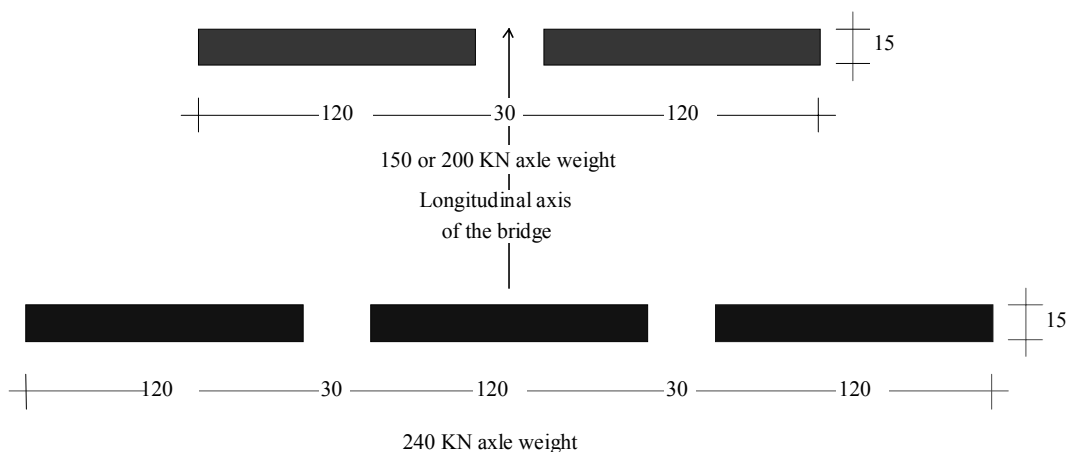


Fig. 17. Axle lines and wheel contact areas for special vehicles

Vehicles with axle loads in the interval 150 to 200 kN occupy the notional lane n. 1, while

vehicles with 240 kN axle load occupy two adjacent notional lane, numbered as n. 1 and n. 2 (fig. 18). The lanes are situated in the most unfavorable position, at most excluding the hard shoulders, hard strips and marker strips.

Since special vehicles are assumed to move at low speed (5 km/h), the axle load values include dynamic magnification.

Concomitance of the special vehicles with the load model n. 1 could be taken into account as follows: the lane or the two lanes occupied by the standardized special vehicle are kept free, in the longitudinal direction, at least for 25 m each side (fig. 19) from the front axle and the rear axle of the special vehicle itself, considering the remaining parts of the notional lanes and of the carriageway loaded with the frequent values of the principal model (fig. 19).

Vehicle weight	150 kN axle loads			200 kN axle loads		
	Geometry	Axle loads	Vehicle type	Geometry	Axle loads	Vehicle type
600 kN	3×1.5 m	4×150 kN	600/150			
900 kN	5×1.5 m	4×150 kN	900/150			
1200 kN	7×1.5 m	4×150 kN	1200/150	5×1.5 m	6×200 kN	1200/200
1500 kN	9×1.5 m	4×150 kN	1500/150	7×1.5 m	1×100+7× 200 kN	1500/200
1800 kN	11×1.5 m	4×150 kN	1800/150	8×1.5 m	9×200 kN	1800/200
2400 kN				11×1.5 m	12×200 kN	2400/200
2400 kN				5×1.5+12+5×1.5 m	12×200 kN	2400/200/200
3000 kN				14×1.5 m	15×200 kN	3000/200
3000 kN				7×1.5+12+6×1.5 m	15×200 kN	3000/200/200
3600 kN				17×1.5 m	18×200 kN	3600/200

Table 8.a. Special vehicles – 150 and 200 kN axle weight

Vehicle weight	240 kN axle loads		
	Geometry	Axle loads	Vehicle type
2400 kN	8×1.5 m	10×240 kN	2400/240
3000 kN	12×1.5 m	1×120+12×200 kN	3000/240
3600 kN	14×1.5 m	15×240 kN	3600/240
3600 kN	7×1.5+12+6×1.5 m	15×200 kN	3600/240/240

Table 8.b. Special vehicles – 240 kN axle weight

3.6 Load model n. 4 – Crowd loading

The uniformly distributed load model n. 4, the crowd loading, is particularly significant for bridges situated in urban areas and it should be considered only when expressly demanded. The

nominal value of the load, including dynamic amplification, is equal to 5.0 kN/m^2 , while the combination value is reduced to 2.5 kN/m^2 .

The crowd loading should be applied on the relevant parts of the length and width of the bridge deck, including the central reservation, if necessary.

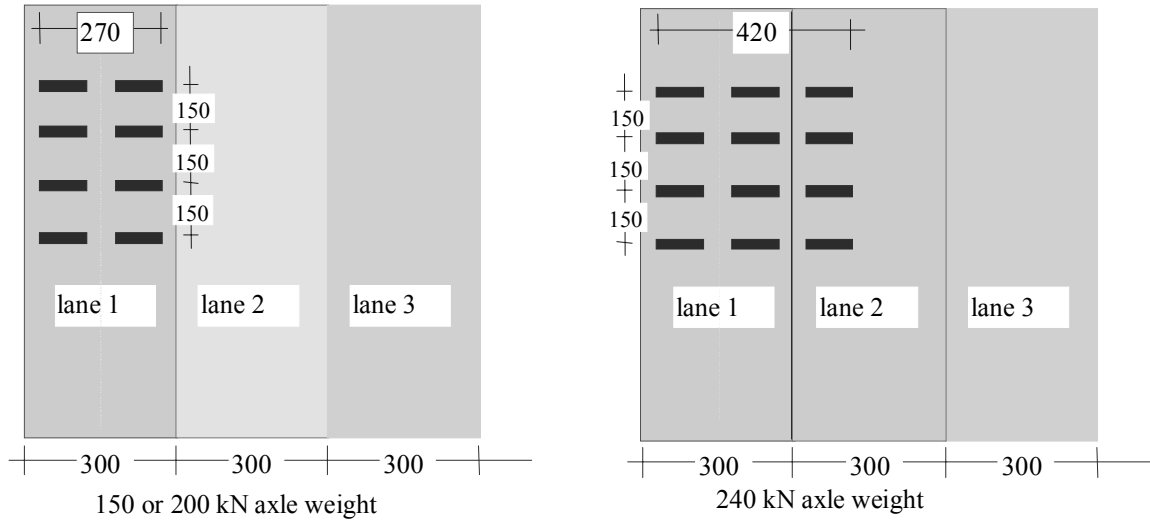


Fig. 18. Arrangement of special vehicle on the carriageway

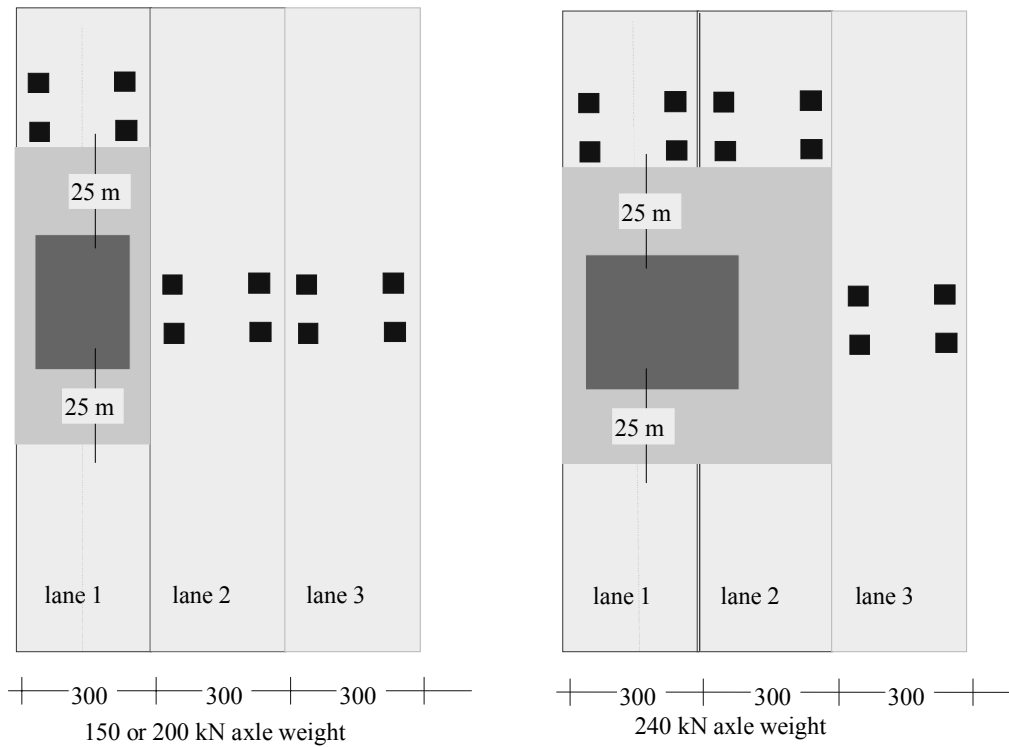


Fig. 19. Simultaneity of special vehicles and load model n. 1

3.7 Characteristic values of horizontal actions

3.7.1 Braking and acceleration forces

The braking or acceleration force, denoted by Q_{lk} , shall be taken as a longitudinal force acting at finished carriageway level.

The characteristic values of Q_{lk} should be calculated as a fraction of the total maximum vertical load corresponding to the load model n. 1 likely to be applied on notional lane n. 1, as follows

$$180 \cdot \alpha_{Q_l} \text{ kN} \leq Q_{lk} = 0.6 \cdot \alpha_{Q_l} \cdot (2 \cdot Q_{lk}) + 0.10 \cdot \alpha_{q_l} \cdot q_{lk} \cdot w_1 \cdot L \leq 900 \text{ kN}, \quad (16)$$

being w_1 the width of the lane and L the length of the loaded zone.

This force, that includes dynamic magnification, should be considered located along the axis of any lane. When the eccentricity is not significant, the force may be considered applied along the carriageway axis and uniformly distributed over the loaded length.

3.7.2 Centrifugal force

The centrifugal force Q_{tk} is a transverse force acting at the finished carriageway level and radially to the axis of the carriageway. Unless otherwise specified, Q_{tk} should be considered as a point load at any deck cross section.

The characteristic value of Q_{tk} , with the dynamic magnification included, depends on the horizontal radius r [m] of the carriageway centreline and on the total maximum weight of the vertical concentrated loads of the tandem systems of the main loading system Q_v

$$Q_v = \sum_i \alpha_{Q_i} \cdot (2 \cdot Q_{ik}), \quad (18)$$

and is given by

$$Q_{tk} = 0.2 \cdot Q_v \text{ [kN]}, r < 200 \text{ m}; \quad Q_{tk} = 40 \cdot \frac{Q_v}{r} \text{ [kN]}, 200 \text{ m} \leq r \leq 1500 \text{ m}; \quad (19)$$

$$Q_{tk} = 0, r > 1500 \text{ m}.$$

4. COMBINATION OF MULTI-COMPONENT ACTIONS

As known, combination rule format for static ULS verifications in EN 1990 is

$$E_d = E \left\{ \gamma_{G,j} G_{k,j}; \gamma_P P; \gamma_{Q,1} Q_{k,1}; \Psi_{0,i} Q_{k,i} \right\} \quad j \geq 1; i > 1, \quad (20)$$

where combination in brackets { } may either be expressed as

$$\sum_{j \geq 1} \gamma_{G,j} G_{k,j} + \gamma_P P + \gamma_{Q,1} Q_{k,1} + \sum_{i > 1} \gamma_{Q,i} \Psi_{0,i} Q_{k,i}, \quad (21)$$

or, alternatively, for structural (STR) and geotechnical (GEO) limit states, as the less favorable of the two following expressions:

$$\sum_{j \geq 1} \gamma_{G,j} G_{k,j} + \gamma_P P + \gamma_{Q,1} \psi_{0,1} Q_{k,1} + \sum_{i > 1} \gamma_{Q,i} \psi_{0,i} Q_{k,i}, \quad (21a)$$

$$\sum_{j \geq 1} \xi_j \gamma_{G,j} G_{k,j} + \gamma_P P + \gamma_{Q,1} Q_{k,1} + \sum_{i > 1} \gamma_{Q,i} \psi_{0,i} Q_{k,i} \quad (21b)$$

being ξ a reduction factor for the permanent unfavorable actions G.

When the occurrence of simultaneity of traffic actions with non-traffic loads is significant, the characteristic values of the traffic actions can be determined considering the five different, and mutually exclusive, group of loads reported in table 9, where the dominant component action is underlined. Each of these groups of loads should be considered as defining a characteristic action for combination with non-traffic loads.

The above mentioned groups of loads can be used also to evaluate the infrequent and frequent values. To obtain infrequent combination values it is sufficient to replace in table 9 characteristic values with the infrequent ones, leaving unchanged the others, while frequent combination values are obtained replacing characteristic values with the frequent ones and equating to zero all the others. The ψ -factors for bridge loads are reported in table 10.

The recommended values of ψ_0 , ψ_1 , ψ_2 for gr1a, referring to load model n.1 are intended given for routes with traffic corresponding to adjusting factors α_{Q_i} , α_{q_i} , α_{q_r} and β_Q equal to 1. Those relating to UDL correspond to the most common traffic scenarios, in which an accumulation of lorries can occur, but not frequently. Other values may be envisaged for other classes of routes, or of expected traffic, related to the choice of the corresponding α factors. For example, as stated before, for special traffic situations, like for bridges in urban areas, a value of ψ_2 other than zero may be envisaged for the UDL system of LM1 only, in consideration of the severe presence of continuous traffic.

The factors for the UDL, given in table 10, apply not only to the distributed part of LM1, but also to the combination value of the pedestrian load mentioned in table 9.

		<i>Carriageway</i>				<i>Footways and cycle tracks</i>
		Vertical loads		Horizontal loads		Vertical loads only
Group of loads	Main load model	Special vehicles	Crowd loading	Braking force	Centrifugal force	Uniformly distributed loads
1	Characteristic values					Combination value
2	Frequent values			Characteristic values	Characteristic values	
3						Characteristic values
4			Characteristic values			Characteristic values
5	see 3.5 and figure 19	Characteristic values				

Table 9. Assessment of characteristic values of multi-component action

Action	Symbol	ψ_0	ψ_{1infq}	ψ_1	ψ_2	
Traffic loads (see table 9)	gr1a (LM1)	TS	0.75	0.80	0.75	0
		UDL	0.40	0.80	0.40	0
	gr1b (single axle)		0	0.80	0.75	0
	gr2 (Horizontal Forces)		0	0	0	0
	gr3 (Pedestrian loads)		0	0.80	0	0
	gr4 (LM4 – Crowd loading))		0	0.80	0.75	0
gr5 (LM3 – Special vehicles))		0	1.0	0	0	
Wind forces	F_W					
	- Persistent design situations		0.6	0.6	0.2	0
	- Execution		0.8	1.0	---	0
F_W^*		1.0	0.6	---	---	
Thermal Actions	T		0.6	0.8	0.6	0.5
Snow loads	S_n (during execution)		0.8	1.0	-	0
Construction loads	Q_c					
	- Working personal, staff and visitors with small equipment (Q_{ca})		1.0	1.0	---	0.2
	- Storage of construction material, precast elements, etc. (Q_{cb})		1.0	1.0	---	1.0
	- Heavy equipment etc. (Q_{cc})		1.0	1.0	---	1.0
- Cranes, lifts, vehicles etc. (Q_{cd})		1.0	1.0	---	1.0	

Table 10. Recommended values of ψ -factors for road bridges

The recommended ψ values for thermal actions may in most cases, according to design Eurocodes, be reduced to 0 for ultimate limit states EQU, concerning assessment of static equilibrium, and STR, concerning structural assessments, described in point 5.

The National annex may refer to the infrequent combination of actions, used for certain serviceability limit states of concrete bridges. The expression of this combination of actions is the following one

$$E_d = E\{G_{k,j}; P; \psi_{1,infq} Q_{k,1}; \psi_{1,i} Q_{k,i}\} \quad j \geq 1; i > 1, \quad (22)$$

where combination in brackets { } may be expressed as

$$\sum_{j \geq 1} G_{k,j} + P + \psi_{1,infq} Q_{k,1} + \sum_{i > 1} \psi_{1,i} Q_{k,i}. \quad (23)$$

In this case, the recommended values of $\psi_{1,infq}$ are the following ones:

- 0,80 for gr1a (LM1), gr1b (LM2), gr3 (pedestrian loads), gr4 (LM4, crowd loading) and T

- (thermal actions) ;
- 0,60 for F_w in persistent design situations
 - 1,00 in other cases (*i.e.* the characteristic value is substituted for the infrequent value)
- The characteristic values of wind actions and snow loads during execution are defined in EN 1991-1-4 and EN 1991-1-3 respectively. Where relevant, representative values of water actions (Q_{wa}) may be defined for the particular project.
- Depending on the aim and/or on the nature of the loads some combinations should be excluded as rule, according to the following statements:
- a. Load Model 2 should not be combined with any other variable non-traffic load.
 - b. Neither snow nor wind should be combined with :
 - crowd loading on road bridges (LM 4) or the associated group of loads gr4,
 - braking and acceleration forces on road bridges or the centrifugal forces or the associated group of loads gr2,
 - loads on footways and cycle tracks or with the associated group of loads gr3.
 - c. Snow loads should not be combined with Load Model 1 or with the associated groups of loads gr1a and gr1b. Exception might be considered for roofed bridges, according to local climatic conditions.
 - d. No wind action greater than the smaller of F_w^* and $\psi_0 F_{wk}$ should be combined with Load Model 1 nor with the associated group of loads gr1.
 - e. Wind and thermal actions should not be considered as simultaneous actions.

5. DESIGN VALUES OF ACTIONS

5.1 Persistent and transient design situations

The design values of actions for ultimate limit states in the persistent and transient design situations should be in accordance with tables 11, 12 and 13, provided that in cases when the limit state is very sensitive to variations in the magnitude of permanent actions, the upper and lower characteristic values of these actions are considered.

Static equilibrium for bridges should be verified using the design value set A of actions, as given in table 11 (EQU).

Design of structural members not involving geotechnical actions should be verified using the design value set B of actions, as given in table 12 (STR/GEO), according as assessment format is chosen according either equation 21 or equations 21a and 21b.

Design of structural members (footings, piles, front walls of abutments, ballast retention walls, etc.) (STR) involving geotechnical actions and the resistance of the ground (GEO) should be verified, according to the choice made at National level, using one only of the three approaches supplemented in EN 1997 for geotechnical actions and resistances:

- Approach 1 consists in applying in separate calculations design values from table 13 and table 12 to the geotechnical actions as well as the actions on/from the structure. In common cases the sizing of foundations is governed by table 13 set C (GEO) and the structural resistance is governed by table 12 (STR), even if, in some cases, application results more complicated.

- Approach 2 consists in applying design values set B of actions from table 12 (STR/GEO) to the geotechnical actions as well as the actions on/from the structure.

<i>Persistent and transient design situation</i>	<i>Permanent actions</i>		<i>Leading variable action</i>	<i>Accompanying Variable actions (*)</i>	
	Unfavourable	Favourable		Main (if any)	Others
(Eq. 21)	$\gamma_{Gj,sup} G_{kj,sup}$	$\gamma_{Gj,inf} G_{kj,inf}$	$\gamma_{Q,1} Q_{k,1}$		$\gamma_{Q,i} \psi_{0,i} Q_{k,i}$

(*) Variable actions are those considered in table 10.

The γ values may be set by the National annex. For persistent design situations, the recommended set of values for γ are :

$$\gamma_{Gj,sup} = 1,05$$

$$\gamma_{Gj,inf} = 0,95$$

$$\gamma_{Q,1} = 1,35 \text{ for road and pedestrian traffic actions, where unfavourable (0 where favourable)}$$

$$\gamma_{Q,1} = 1,45 \text{ for rail traffic actions, where unfavourable (0 where favourable)}$$

$$\gamma_{Q,i} = 1,50 \text{ for all other variable actions for persistent design situations, where unfavourable (0 where favourable)}$$

$$\gamma_{Q,1} = 1,35 \text{ for all variable actions during execution, where unfavourable (0 where favourable)}$$

For transient design situations during which there is a risk of loss of static equilibrium, $Q_{k,1}$ represents the dominant destabilising variable action and $Q_{k,i}$ represents the relevant accompanying destabilising variable actions. The recommended set of values for γ are :

$$\gamma_{Gj,sup} = 0,95$$

$$\gamma_{Gj,inf} = 1,05^{(1)}$$

$$\gamma_{Q,1} = 1,35 \text{ for construction loads (0 where favourable)}$$

$$\gamma_{Q,i} = 1,50 \text{ for all other variable actions during execution, where unfavourable (0 where favourable)}$$

⁽¹⁾ Where a counterweight is used, the variability of its characteristics may be taken into account, for example, by one or both of the following recommended rules :

- applying a partial factor $\gamma_{G,inf} = 0,8$ where the self-weight is not well defined (e.g. containers) ;

- by considering a variation of its project-defined location, with a value to be specified proportionately to the dimensions of the bridge, where the magnitude of the counterweight is well defined. For steel bridges during launching, the variation of the counterweight location is often taken equal to ± 1 m.

In cases where the verification of static equilibrium also involves the resistance of structural elements (for example where loss of static equilibrium is prevented by stabilising systems or devices like anchors, stays or auxiliary columns), as an alternative to two separate verifications based on Tables A2.4(A) and A2.4(B), a combined verification, based on Table A2.4(A), may be adopted with the following set of recommended values, which may be altered by the National annex.

$$\gamma_{Gj,sup} = 1,35$$

$$\gamma_{Gj,inf} = 1,15$$

$$\gamma_{Q,1} = 1,35 \text{ for road and pedestrian traffic actions, where unfavourable (0 where favourable)}$$

$$\gamma_{Q,1} = 1,45 \text{ for rail traffic actions, where unfavourable (0 where favourable)}$$

$$\gamma_{Q,i} = 1,50 \text{ for all other variable actions for persistent design situations, where unfavourable (0 where favourable)}$$

$$\gamma_{Q,1} = 1,35 \text{ for all variable actions during execution, where unfavourable (0 where favourable)}$$

provided that applying $\gamma_{Gj,inf} = 1,00$ both to the favourable part and to the unfavourable part of permanent actions does not give a more unfavourable effect.

Table 11. Design values of actions (EQU) (Set A)

Persistent and transient design situation	Permanent actions		Leading variable action	Accompanying Variable actions (*)	
	Unfavourable	Favourable		Main (if any)	Others
(Eq. 21)	$\gamma_{Gj,sup} G_{kj,sup}$	$\gamma_{Gj,inf} G_{kj,inf}$	$\gamma_{Q,1} Q_{k,1}$		$\gamma_{Q,i} \psi_{0,i} Q_{k,i}$
Persistent and transient design situation	Permanent actions		Leading variable action	Accompanying Variable actions (*)	
	Unfavourable	Favourable		Main (if any)	Others
(Eq. 21a)	$\gamma_{Gj,sup} G_{kj,sup}$	$\gamma_{Gj,inf} G_{kj,inf}$		$\gamma_{Q,1} \psi_{0,1} Q_{k,1}$	$\gamma_{Q,i} \psi_{0,i} Q_{k,i}$
(Eq. 21b)	$\xi \gamma_{Gj,sup} G_{kj,sup}$	$\gamma_{Gj,inf} G_{kj,inf}$	$\gamma_{Q,1} Q_{k,1}$		$\gamma_{Q,i} \psi_{0,i} Q_{k,i}$

(*) Variable actions are those considered in table 10.

The choice between equations 21, or 21a and 21b will be in the National annex.

The γ and ξ values may be set by the National annex. The following values for γ and ξ are recommended when using expressions 21, or 21a and 21b:

$$\gamma_{Gj,sup} = 1,35^{1)}$$

$$\gamma_{Gj,inf} = 1,00$$

$\gamma_{Q,1} = 1,35$ when Q_1 represents unfavourable actions due to road or pedestrian traffic (0 when favourable)

$$\gamma_{Q,i} = 1,50 \text{ for other traffic actions and other variable actions } ^{2)}$$

$$\xi = 0,85 \text{ (so that } \xi \gamma_{Gj,sup} = 0,85 \times 1,35 \cong 1,15).$$

See also EN 1991 to EN 1999 for γ values to be used for imposed deformations.

¹⁾ $\gamma_{Gj,sup} = 1,35$ covers : self-weight of structural and non structural elements, ballast, soil, ground water and free water, removable loads, etc.

²⁾ $\gamma_{Q,i} = 1,50$ covers : variable horizontal earth pressure from soil, ground water, free water and ballast, traffic load surcharge earth pressure, traffic aerodynamic actions, wind and thermal actions, etc.

The characteristic values of all permanent actions from one source are multiplied by $\gamma_{G,sup}$ if the total resulting action effect is unfavourable and $\gamma_{G,inf}$ if the total resulting action effect is favourable. For example, all actions originating from the self weight of the structure may be considered as coming from one source ; this also applies if different materials are involved.

For particular verifications, the values for γ_G and γ_Q may be subdivided into γ_g and γ_q and the model uncertainty factor γ_{sd} . A value of γ_{sd} in the range 1,0 - 1,15 can be used in most common cases and can be modified in the National annex.

Where actions due to water are not covered by EN 1997 (e.g. flowing water), the combinations of actions to be used should be agreed with the client or the relevant authority for the particular project.

Table 12. Design values of actions (STR/GEO) (Set B)

- Approach 3 consists in applying design value set C of actions from table 13 (GEO) to the geotechnical actions and, simultaneously, applying design values set B of actions from table 12 (STR) to the actions on/from the structure.

Site stability (e.g. the stability of a slope supporting a bridge pier) as well as hydraulic and buoyancy failure (e.g. in the bottom of an excavation for a bridge foundation), if relevant, shall be verified in accordance with EN 1997.

In the cases where they are not provided in the relevant design Eurocodes (EN 1992 to EN 1999),

the γ_p values to be used for prestressing actions should be specified for the relevant representative values, depending on the type of prestress, its classification as direct or indirect action, the type of structural analysis and, finally, the unfavourable or favourable character, and the leading or accompanying character of prestress in the considered combination.

Persistent and transient design situation	Permanent actions		Leading variable action	Accompanying Variable actions (*)	
	Unfavourable	Favourable		Main (if any)	Others
(Eq. 21)	$\gamma_{Gj,sup} G_{kj,sup}$	$\gamma_{Gj,inf} G_{kj,inf}$	$\gamma_{Q,1} Q_{k,1}$		$\gamma_{Q,i} \psi_{0,i} Q_{k,i}$

(*) Variable actions are those considered in table 10

The γ values may be set by the National annex. The recommended set of values for γ are :

$\gamma_{Gj,sup} = 1,00$
 $\gamma_{Gj,inf} = 1,00$
 $\gamma_{Q,1} = 1,15$ for road and pedestrian traffic actions where unfavourable (0 where favourable)
 $\gamma_{Q,1} = 1,30$ for the variable part of horizontal earth pressure from soil, ground water, free water and ballast, for traffic load surcharge horizontal earth pressure, where unfavourable (0 where favourable)
 $\gamma_{Q,i} = 1,30$ for all other variable actions where unfavourable (0 where favourable)

Table 13. Design values of actions (STR/GEO) (Set C)

5.2 Accidental and seismic design situations

General format of effects of actions in accidental and seismic situations are

$$E_d = E\{G_{k,j}; P; A_d; (\psi_{1,1} \text{ or } \psi_{2,1}) Q_{k,1}; \psi_{2,i} Q_{k,i}\} \quad j \geq 1; i > 1, \text{ and} \quad (24)$$

$$E_d = E\{G_{k,j}; P; \gamma_1 A_{Ek} \text{ or } A_{Ed}; \psi_{2,i} Q_{k,i}\} \quad j \geq 1; i > 1, \quad (25)$$

respectively, where combination in brackets { } may be expressed as

$$\sum_{j \geq 1} G_{k,j} + P + A_d + (\psi_{1,1} \text{ or } \psi_{2,1}) Q_{k,1} + \sum_{i > 1} \psi_{2,i} Q_{k,i}, \text{ and} \quad (26)$$

$$\sum_{j \geq 1} G_{k,j} + P + \gamma_1 A_{Ek} \text{ or } A_{Ed} + \sum_{i > 1} \psi_{2,i} Q_{k,i}. \quad (27)$$

The partial factors for actions for the ultimate limit states in the accidental and seismic design situations (expressions 24 to 27) should all be 1,0 as synthesized in table 14, where ψ values are given in table 10.

In special cases, if one or several variable actions need to be considered simultaneously with the accidental action, their representative values should be defined. For example, in the case of bridges built by the cantilevered method, some construction loads may be considered as simultaneous with the accidental action corresponding to the fall of a prefabricated unit.

For transient design situations during which there is a risk of loss of static equilibrium, the combination of actions should be as follows :

$$\sum_{j \geq 1} G_{k,j} " + " P " + " A_d " + " \Psi_{0,1} Q_{k,c,1} " + " \sum_{i > 1} \Psi_{2,i} Q_{k,ci} , \text{ and} \quad (28)$$

where $Q_{k,ci}$ is one of the groups of construction loads defined in EN 1991-1-6 (*i.e.* Q_{ca} , Q_{cb} , Q_{cc} or Q_{cd}) and P is a characteristic or a mean value depending, at the time under consideration, on the particular project. It must be noted here, that this combination of actions, different from the general expression (26), is proposed for bridges for the sake of simplicity, to avoid the definition of frequent values of the variable actions during execution steps.

For seismic situation additional information are given in EN1998.

Design situation	Permanent actions		Leading accidental or seismic action	Accompanying variable actions (**)	
	Unfavourable	Favourable		Main (if any)	Others
Accidental(*) (Eq. 24 and 26)	$G_{kj,sup}$	$G_{kj,inf}$	A_d	Ψ_{11} or $\Psi_{21} Q_{k1}$	$\Psi_{2,i} Q_{k,i}$
Seismic (***) (Eq. 25 and 27)	$G_{kj,sup}$	$G_{kj,inf}$	γA_{Ek} or A_{Ed}	$\Psi_{2,i} Q_{k,i}$	

(*) In the case of accidental design situations, the leading variable action may be taken with its frequent or, as in seismic combinations of actions, its quasi-permanent values. The choice will be in the National annex, depending on the accidental action under consideration.

(**) Variable actions are those considered in tables 10.

(***) Certain seismic design situations may have to be taken into account, especially for railway bridges (see National annex).

Table 14. Design values of actions in the accidental and seismic design situations

5.3 Serviceability limit states

For serviceability limit states the partial factors for actions should all be taken as 1.0, except if differently specified in EN1991 to EN1999, or for the particular project.

The serviceability criteria should be defined in relation to the serviceability requirements given in accordance with EN 1992 to EN 1999 for the particular project.

Appropriate combinations of actions should be considered, according the design values given in table 15, taking into account serviceability requirements as well as the distinction between reversible and irreversible limit states.

Combination	Permanent actions G_d		Variable actions Q_d	
	Unfavourable	Favourable	Leading	Others
Characteristic	$G_{kj,sup}$	$G_{kj,inf}$	$Q_{k,1}$	$\Psi_{0,i} Q_{k,i}$
Frequent	$G_{kj,sup}$	$G_{kj,inf}$	$\Psi_{1,1} Q_{k,1}$	$\Psi_{2,i} Q_{k,i}$
Quasi-permanent	$G_{kj,sup}$	$G_{kj,inf}$	$\Psi_{2,1} Q_{k,1}$	$\Psi_{2,i} Q_{k,i}$

Table 15. Design values of actions for use in the combination of actions for SLS

6 DEVELOPMENT OF THE FATIGUE LOAD MODELS OF EN 1991-2

In this Section the pre-normative background studies which have been carried out in the framework of EN 1991-2 to define fatigue loads models for road traffic are discussed, together with the main features of the models themselves.

6.1 Fatigue load modeling

As known, *fatigue is the progressive, localised and permanent structural change occurring in a material subjected to conditions that produce fluctuating stresses and strains at some point or points and that may culminate in cracks or complete fracture after a sufficient number of fluctuations.*

In engineering structures fatigue is induced by actions and loads varying with time and/or space and/or by random vibrations. Thus fatigue can be originated by natural events, like waves, wind and so on, or by loads deriving from the normal service of the structure itself.

Among structures, bridges are exposed to fatigue, under the action of lorries or trains crossing the bridges themselves. The assignment of appropriate fatigue load models is therefore a key topic in modern bridge design codes of practice.

In principle, modelling of fatigue loads asks for the complete knowledge of the so-called load spectrum, expressing the load variation or the number of recurrences of each load level during the design life of the structure. Load spectrum is generally given in terms of an appropriate function, graph, histogram or table.

The load spectrum is often deduced from recorded data, referring to relatively short time intervals. In this case, additional problems must be faced regarding the statistical processing, the reliability over longer periods and the future trends of available data.

Whenever, as it happens for bridge, the real load spectrum results are so complicated that cannot be directly employed for fatigue checks, it is replaced by some conventional load spectrum, aimed to reproduce the fatigue induced by the real one.

The evaluation of conventional load spectra is particularly problematic, because it requires to consider the actions from the resistance point of view also. In fact, fatigue depends on the nature of the varying actions and loads, and additionally on structural material details, through the shape and the properties of the relevant S-N curves.

Problems become even tougher when endurance (fatigue) limit exists. In fact, because fatigue limits under constant amplitude represents a threshold value for the damaging stress range, it needs to distinguish between equivalent load spectra, reproducing the actual fatigue damage, and frequent load spectra, reproducing the maximum load range significant for fatigue, accordingly as fatigue verifications require cumulative damage computations or boundless fatigue life assessments.

Moreover, the powerful methods of the stochastic process theory, often used in defining fatigue load spectra in other engineering structures, cannot be applied to bridges, as road traffic loads induce broad band stress histories. All that implies that the link between the action and the effect cannot be expressed by simple formulae, while further difficulties arise when vehicle interactions, whether due to simultaneity or not, become significant.

Nevertheless, provided that vehicle interaction problems can be solved in some way, as shown in

the following, it is intuitive enough to think that fatigue load spectra for bridges are composed by suitable sets of standardised lorries, where each lorry is associated to its own relevant properties, i.e. frequency, number of axles, axle loads, inter-axle distances, as deduced processing the relevant traffic measurements.

At this stage, it appears quite evident that the definition of load spectra for bridges requires careful consideration of fatigue assessment methodology, to assure that conventional spectra and real spectra demand the same fatigue resistance.

6.1.1 Fatigue verification methods

The preliminary explanation of fatigue assessment methodology based on conventional load spectra is a crucial question in studying fatigue load models.

It can be easily recognised that fatigue verification methods goes along with a well-defined procedure, characterised by the following steps

- 1 assignment of fatigue load spectra, discriminating, if necessary, equivalent ones from frequent ones;
- 2 detection and classification of structural details most vulnerable to fatigue cracking and selection of the appropriate S-N curves;
- 3 choice of the pertinent partial safety factors γ_M ;
- 4 evaluation, for each detail, of the appropriate influence surface.

At this stage, the methodology branches accordingly as fatigue verification is devoted to compute fatigue damage or to assess boundless fatigue life.

Damage computation procedure

- 5.a calculation of the design stress history $\sigma=\sigma(t)$ produced in the detail by the equivalent load spectrum transiting over the influence surface;
- 6.a analysis of the stress history by means of a suitable cycle counting method, like the reservoir method or the rainflow method, to obtain the stress spectrum, giving the number of occurrences of each stress range in the reference time interval;
- 7.a computation of the cumulative damage D using the Palmgren-Miner rule: if $D\leq 1$ the fatigue check is satisfied, otherwise, it is necessary to raise the fatigue strength of the detail. Fatigue resistance can be enhanced both reducing the stress range, i.e. enlarging the dimensions, or increasing fatigue category, i.e. adopting more refined workmanship or details.

Boundless fatigue life assessment

- 5.b calculation of the design stress history $\sigma=\sigma(t)$ produced in the detail by the frequent load spectrum transiting over the influence surface;
- 6.b computation of the maximum stress range $\Delta\sigma_{\max}=\sigma_{\max}-\sigma_{\min}$, being σ_{\max} and σ_{\min} , respectively, the absolute maximum and the absolute minimum of the stress history;
- 7.b boundless fatigue life assessment. If the verification is not satisfied, it is possible to improve fatigue resistance using the provisions described in 7.a, or to attempt to go through fatigue damage computation.

Evidently, in bridges exposed to high-density traffic typical concrete slab and orthotropic steel deck details are subject to such a huge number of stress cycles, that boundless fatigue life

assessment using frequent load spectra becomes quite obligatory.

6.1.2 Reference traffic measurements

Also the fatigue load models of Eurocode 1 have been defined and calibrated on the basis of the two large measurement campaigns illustrated before. Carried out during the years 1977 to 1982 and 1984 to 1988, in several European countries.

Unlike static loads, which depend only on the upper tail, fatigue loads are influenced by the whole traffic load distribution. Fatigue models have been so refined, widening their field of application, supplementing the main calibration, based on Auxerre data, with secondary calibration considering other traffic measurements.

As motorways and main roads, serving long distance itineraries, are affected by heavy commercial traffic, characterised by high percentage of articulated lorries, while secondary roads, serving local itineraries, are affected by lighter commercial traffic, composed mostly by two axle lorries, the secondary calibration regarded motorway traffic - Auxerre (F), Brothal (D), Piacenza, Fiano Romano, Sasso Marconi (I) - as well as local traffic on secondary roads (Epone (F)).

The studies have also taken into account the expected traffic trend, that should cause, as confirmed by new measures,

- a marked increase of articulated lorries percentage vis-à-vis simultaneous reduction of lorries with trailer percentage;
- a reduction of the three axle lorries percentage for the benefit of two axle lorries;
- an increase of the average load per lorry.

6.2 The fatigue load models of EN 1991-2

The calibration method, the underlying philosophy, and the main features of the fatigue models of Eurocode 1 are summarised below, stressing the methodological approach.

6.2.1 Calibration method

Fatigue load models have been defined considering reference influence surfaces relative to simply supported and continuous bridges spanning in the interval 3 to 200 m.

In agreement with the fatigue verification procedure, calibration has been set-up according to the following scheme,

- choice of the most significant European traffic data;
- selection of appropriate S-N curves;
- evaluation of the stress histories in reference bridges;
- cycle counting and stress spectra computation;
- first identification of fatigue models;
- definition of standardised lorry geometries;
- calibration of frequent load models, best fitting the maximum stress range $\Delta\sigma_{\max}$ induced by the real traffic;
- calibration of equivalent load models, best fitting the fatigue damage D induced by the real traffic.

6.2.2 Reference S-N curves

Reference S-N curves pertain to steel details, characterised by endurance limit. As known, in the logarithmic S-N chart these curves are represented by a bilinear curve, characterised by a sloping branch of constant slope, $m=3$, (fig. 20), or by a trilinear curve, characterised by two sloping branches, $m=3$ and $m=5$, (fig. 21), according as boundless fatigue life or fatigue damage is to be assessed.

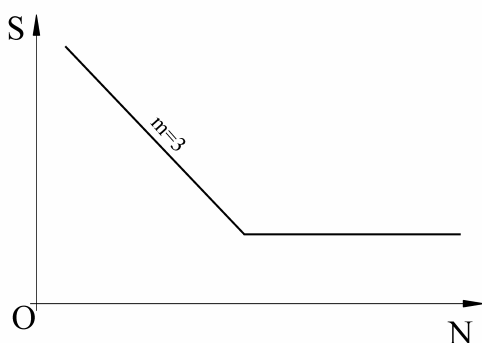


Fig. 20. Bilinear S-N curve

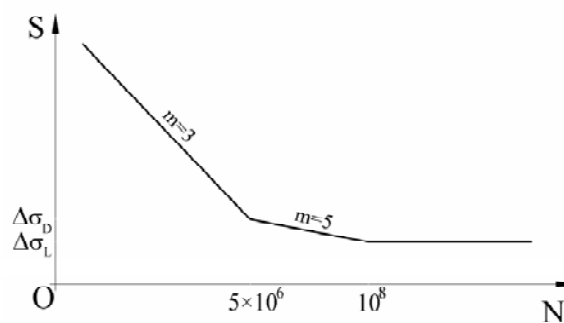


Fig. 21. Trilinear S-N curve

As the fatigue limit $\Delta\sigma_D$ is taken into account, the maximum stress range $\Delta\sigma_{\max}$ of the real stress history can be above or below this limit.

The conventional load models are then devoted to reproduce the actual fatigue damage or $\Delta\sigma_{\max}$, accordingly as $\Delta\sigma_{\max} > \Delta\sigma_D$ or not.

To be significant for fatigue, $\Delta\sigma_{\max}$ must be exceeded several times during the bridge life and its definition is not trivial, in fact. Two different approaches, leading to similar results, have been proposed. In the former $\Delta\sigma_{\max}$ is defined as the stress range such that the 99% of the total fatigue damage results from all stress ranges below $\Delta\sigma_{\max}$. In the latter $\Delta\sigma_{\max}$ is the stress range exceeded approximately $5 \cdot 10^4$ times during the bridge life. This last definition implies that the return period for $\Delta\sigma_{\max}$ is about half a day, giving so direct explanation of frequent load spectrum denomination.

To derive equivalent spectra independent from fatigue classification, in EN 1991 studies cumulative damage has been computed referring generally to simplified S-N curves with unique slope, in turn $m=3$ (fig. 22) or $m=5$ (fig. 23), while S-N curves with double slope (fig. 24) have been used for some additional calculations. Some comparisons show that load spectra obtained using the simplified curve $m=5$ are free from significant errors and reproduce very well the actual fatigue damage.

6.2.3 Fatigue load models

From the above-mentioned considerations, it derives that at least two conventional fatigue load models must be considered: the one for boundless fatigue life assessments, the other for fatigue damage calculations. Besides, since an adequate fitting of the effects induced by the real traffic requires very sophisticated load models, whose application is often difficult, the introduction of simplified and safe-sided models, to be used when sophisticated checks are unnecessary, seem very opportune.

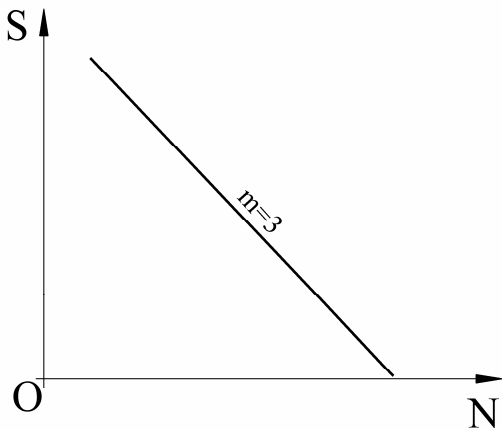


Fig. 22. Single slope $m=3$ S-N curve

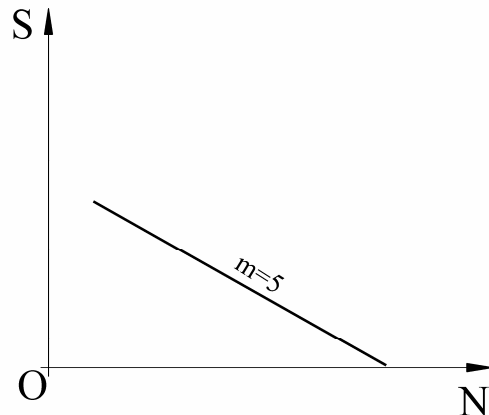


Fig. 23. Single slope $m=5$ S-N curve

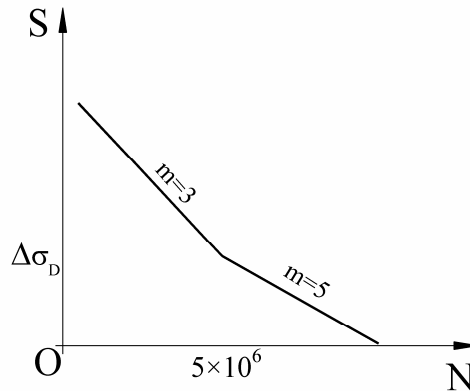


Fig. 24 Double slope $m=3$ - $m=5$ S-N curve

For this reason in EN 1991-2 two fatigue load models are foreseen for each kind of fatigue verification: the former is essential, safe-sided and easy to use, the latter is more refined and accurate, but a little more complicated also. Finally, four conventional models are given:

- models 1 and 2 for boundless fatigue checks;
- models 3 and 4 for damage computations.

Fatigue load model 1 is extremely simple and generally very safe-sided. It directly derives from the main load model used for assessing static resistance, where the load values are simply reduced to the frequent ones (fig. 25.a), multiplying the tandem axle loads Q_{ik} by 0.7 and the weight density of the uniformly distributed loads q_{ik} by 0.3. Obviously, for local verifications, the fatigue load model n. 1 is constituted by the isolated concentrated axle weighing $Q=280$ kN (fig. 25.b).

The verification consists of checking that the maximum stress range $\Delta\sigma_{\max}$ induced by the model is smaller of the fatigue limit $\Delta\sigma_D$. The application rules for the load model n. 1 exactly agree with those given for the main load model, so that the absolute minimum and maximum stresses correspond as rule to different load configurations. The model allows making “coarse” verifications also in multi-lane configurations, generally resulting much safe-sided.

The simplified fatigue model n. 3, conceived for damage computation, is constituted by a symmetrical conventional four axle vehicle, also said fatigue vehicle (fig. 26). The equivalent load of each axle is 120 kN. This model is accurate enough for spans bigger than 10 m, while for

smaller spans it results safe-sided.

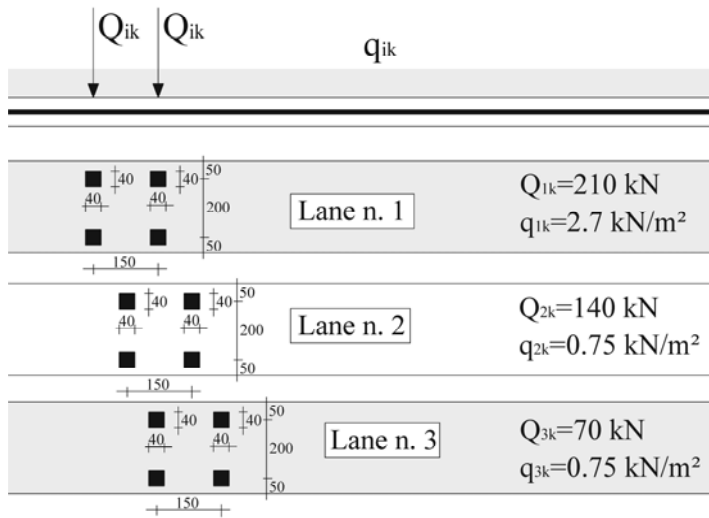


Fig. 25.a. Fatigue load model n. 1

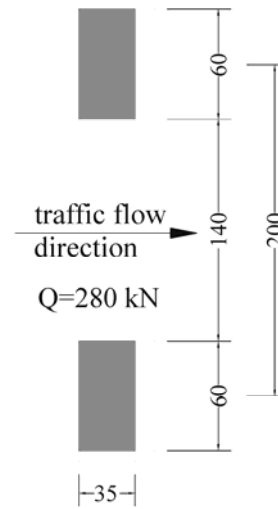


Fig. 25.b. Fatigue load model n. 1 for local verifications

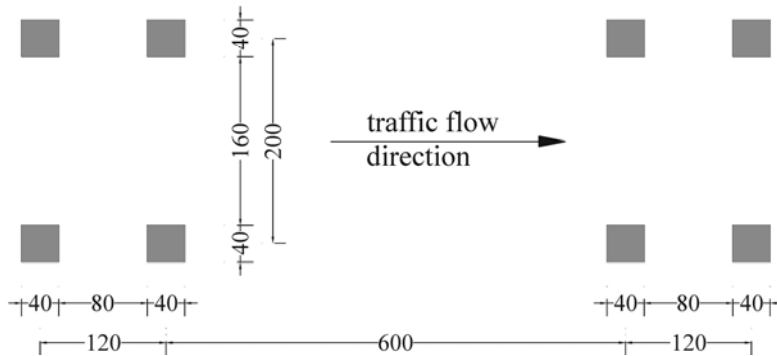


Fig. 26. Fatigue load model n. 3

The most refined fatigue models are load spectra constituted by five standardised vehicles, representative of the most common European lorries.

Fatigue load model n. 2, constituted by a set of lorries with frequent values of axle loads, and fatigue model n. 4, constituted by a set of lorries with equivalent values of the axle loads, are illustrated in tables 16 and 17, respectively. They allow to perform very precise and sophisticated verifications, provided that the interactions amongst vehicles simultaneously crossing the bridge are negligible or opportunely considered.

In effects, in EN 1991-2 a further general purpose fatigue model is anticipated also, denominated fatigue model n. 5. This model is constituted by a sequence of consecutive axle loads, directly derived from traffic measurements, duly supplemented to take into account vehicle interactions, where relevant. Fatigue model n. 5 is aimed to allow accurate fatigue verifications in particular situations, like suspended or cable-stayed bridges, important existing bridges or bridges carrying unusual traffics, whose relevance justifies ad hoc investigations (Caramelli & Croce, 2000).

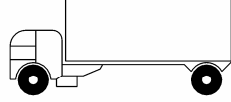
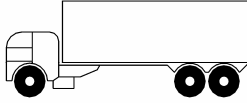
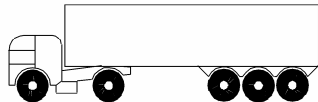
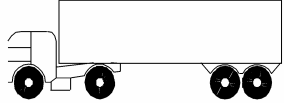
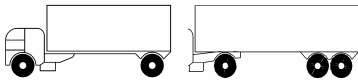
Lorry silhouette	Interaxles [m]	Frequent axle loads [kN]
	4.50	90 190
	4.20 1.30	80 140 140
	3.20 5.20 1.30 1.30	90 180 120 120 120
	3.40 6.00 1.80	90 190 140 140
	4.80 3.60 4.40 1.30	90 180 120 110 110

Table 16. Fatigue load model n. 2

6.2.4 Accuracy of fatigue load models

In the following, some significant results obtained using the fatigue load models are compared with those pertaining to the reference traffic, allowing to point out the accuracy and the field of application of the each conventional model.

Essentially, the comparison concerns the influence surfaces summarised in fig. 27, for bridges span L varying between 3 m and 100 m. The influence surface pertain to bending moment M_0 at midspan of simply supported beams, bending moments M_1 and M_2 at midspan and on the support, respectively, of two span continuous beams and bending moment M_3 at midspan of three span continuous beams.

The comparison are summarised in figures 28 to 32, depending on influence surface and span L .

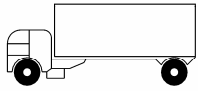
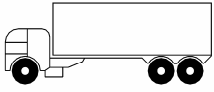
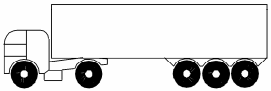
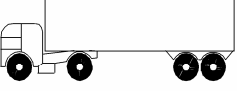
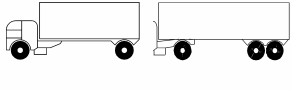
Lorry silhouette	Interaxles [m]	Equivalent axle loads [kN]	Traffic composition [%]		
			Long distance	Medium distance	Local traffic
	4.50	70 130	20.0	50.0	80.0
	4.20 1.30	70 120 120	5.0	5.0	5.0
	3.20 5.20 1.30 1.30	70 150 90 90 90	40.0	20.0	5.0
	3.40 6.00 1.80	70 140 90 90	25.0	15.0	5.0
	4.80 3.60 4.40 1.30	70 130 90 80 80	10.0	10.0	5.0

Table 17. Fatigue load model n. 4

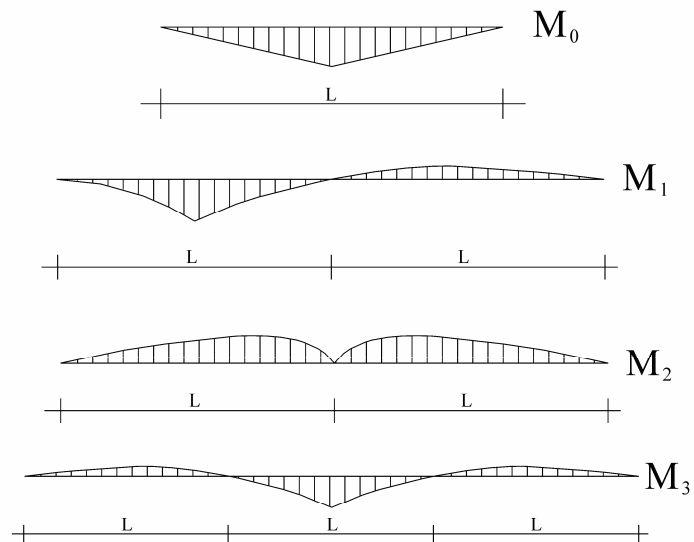


Figure 27. Reference influence lines

Ratios $\frac{\Delta M_{\max,LM1}}{\Delta M_{\max,real}}$ between the maximum stress range $\Delta M_{\max,LM1}$ due to fatigue model n. 1 and the maximum stress range $\Delta M_{\max,real}$ due to Auxerre traffic are plotted versus span in figure 28, while ratios $\frac{\Delta M_{\max,LM2}}{\Delta M_{\max,real}}$ are analogously plotted in figure 29, being $\Delta M_{\max,LM2}$ the maximum stress range due to fatigue load model n. 2. Clearly, model n. 1 appears very safe sided, especially for short spans, while model n. 2 results much more reliable. Values little below the actual ones are estimate for M_2 in the span range 20 to 50 m, because of the particular shape of the influence line.

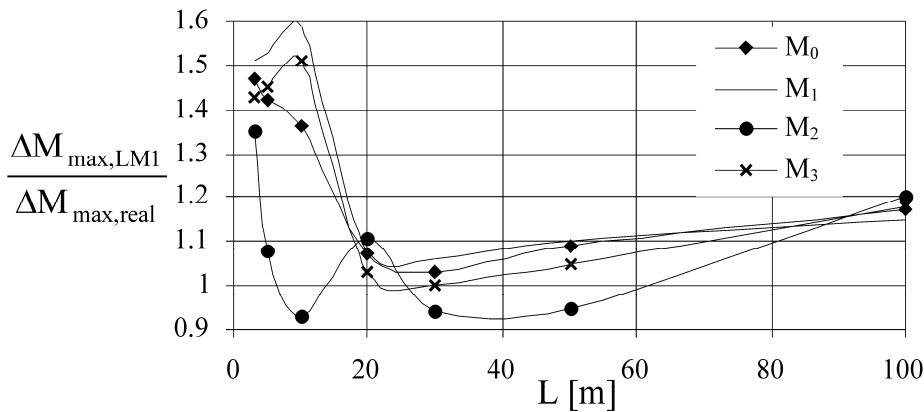


Figure 28. Accuracy of fatigue load model n. 1

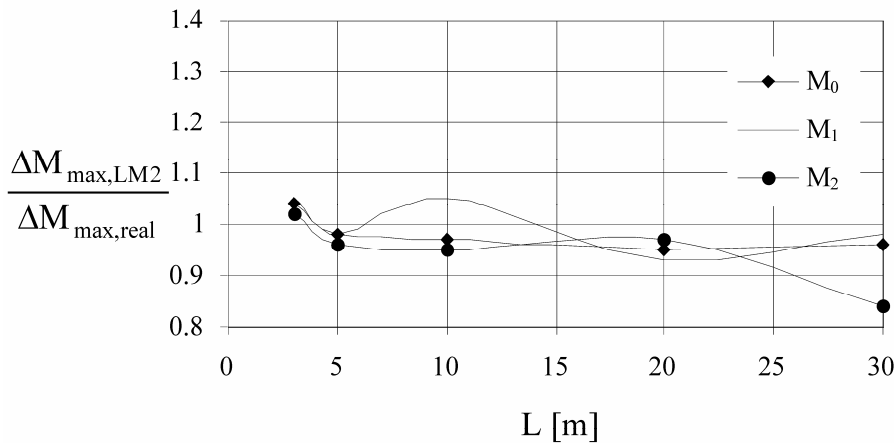


Figure 29. Accuracy of fatigue load model n. 2

Ratios $\frac{\Delta M_{eq,LM3}}{\Delta M_{eq,real}}$ between the equivalent stress range $\Delta M_{eq,LM3}$ due to fatigue load model n. 3 and the equivalent stress range $\Delta M_{eq,real}$ due to Auxerre traffic are plotted in figures 30 and 31, assuming $m=3$ and $m=5$, respectively, for the slope of the linear S-N curve. Analogously, ratios $\frac{\Delta M_{eq,LM4}}{\Delta M_{eq,real}}$ are plotted in figure 32 for $m=3$, being $\Delta M_{eq,LM4}$ the equivalent stress range due to

fatigue load model n. 4. As expected, model n. 4 fits very good actual results for short influence lines.

Fatigue model n. 3 looks unsafe for M_2 influence lines when spans are above 30 m, in particular for higher m values. To solve the problem it has been proposed to modify the model n. 3 considering an additional fatigue vehicle, running on the same lane 40 m after the first and having equivalent axle loads reduced to 40 kN, each time that the influence surface exhibits two contiguous areas of the same sign. The adoption of such an additional vehicle should mitigate the error in computation of $\Delta M_{2,eq}$, as it appears evident in figure 33, where M_2 calculations considering additional fatigue vehicle are summarised for $m=3$ and $m=9$.

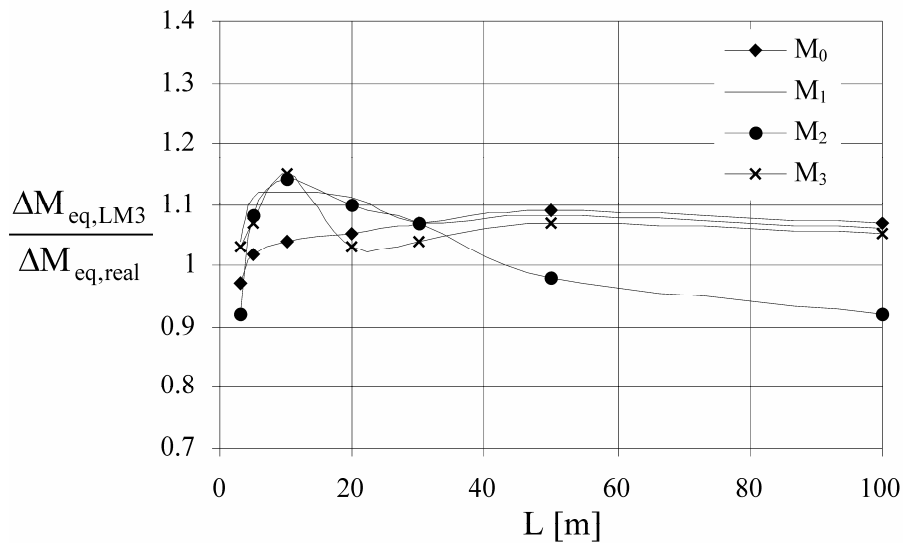


Figure 30. Accuracy of fatigue load model n. 3 – $m=3$

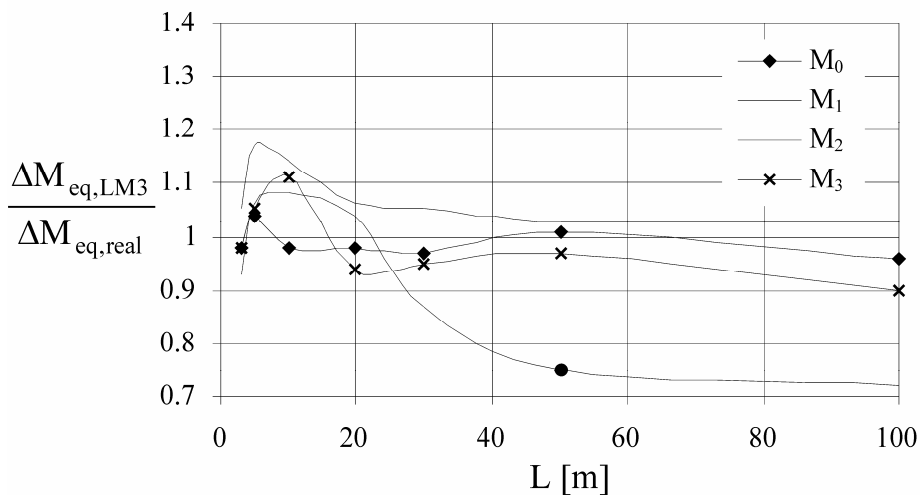


Figure 31. Accuracy of fatigue load model n. 3 – $m=5$

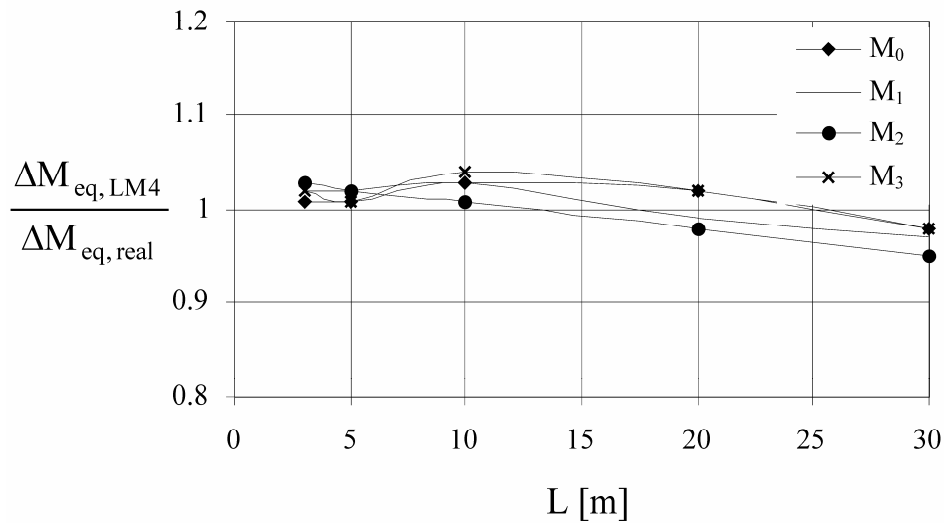


Figure 32. Accuracy of fatigue load model n. 4

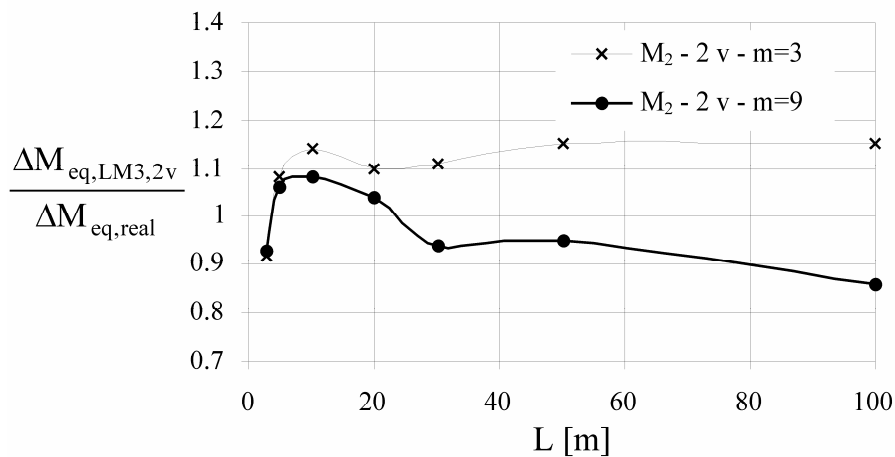


Figure 33. Accuracy of improved fatigue load model n. 3 – 2 vehicles

6.2 The λ -coefficient method

Besides the usual damage computations based on Palmgren-Miner rule, EN 1991-2 also foresees a conventional simplified fatigue assessment method, said λ -coefficient method, based on λ adjustment factors, which are dependent on the material.

The method, derived originally for railway bridges, is based for road bridges on fatigue model n. 3 (fatigue vehicle) and it is aimed to bring back fatigue verifications to conventional resistance checks, comparing a conventional equivalent stress range, $\Delta\sigma_{eq}$, depending on appropriate λ -coefficients, with the detail category (Bruls & al, 1996.a, Croce, 2002).

The equivalent stress range $\Delta\sigma_{eq}$ is given by

$$\Delta\sigma_{eq} = \lambda_1 \cdot \lambda_2 \cdot \lambda_3 \cdot \lambda_4 \cdot \varphi_{fat} \cdot \Delta\sigma_p = \lambda \cdot \varphi_{fat} \cdot \Delta\sigma_p, \quad (28)$$

where

- $\Delta\sigma_p = \sigma_{p,max} - \sigma_{p,min}$ is the maximum stress range induced by fatigue model n. 3;
- λ_1 is a coefficient depending on the shape and on the base length of the influence surface, i.e. on the number of secondary cycles in the stress history;
- λ_2 is a coefficient allowing to pass from reference traffic, used in fatigue model calibration, to expected traffic;
- λ_3 depends on the design life of the bridge;
- λ_4 takes into account vehicle interactions amongst lorries simultaneously crossing the bridge;
- φ_{fat} is the equivalent dynamic magnification factor for fatigue verifications.

The λ_1 values, given in graphical or tabular form, are derived in the calibration phase, comparing the damage due to the fatigue vehicle with the damage produced by a single stress cycle having the maximum stress range $\Delta\sigma_p$. If m is the slope of S-N curve, it is

$$\lambda_1 = \left(\frac{\sum_i n_i \cdot \Delta\sigma_i^m}{\Delta\sigma_p^m} \right)^{\frac{1}{m}}. \quad (29)$$

λ_2 depends on the annual lorry flow and on traffic composition. In general, said N_1 and Q_{m1} the flow and the equivalent weight of the actual traffic,

$$Q_{m1} = \sqrt[m]{\frac{\sum_i n_i \cdot Q_i^m}{\sum_i n_i}}, \quad (30)$$

and N_0 and Q_0 the flow and the equivalent weight of the reference traffic, it results

$$\lambda_2 = k \cdot \frac{Q_{m1}}{Q_0} \cdot \left(\frac{N_1}{N_0} \right)^{\frac{1}{m}}. \quad (31)$$

In the expression (31) k represents a conversion parameter, given by

$$k = \frac{D_{ef}}{D_v} \cdot \frac{Q_0}{Q_{m1}}, \quad (32)$$

where D_v is the damage produced by N_0 fatigue vehicles and D_{ef} is the damage produced by N_0 actual lorries.

For Auxerre traffic it ensues $Q_0 = 480$ kN and $N_0 = 2 \cdot 10^6$ lorries/year.

λ_3 is given by

$$\lambda_3 = \sqrt[m]{\frac{T}{T_R}}, \quad (33)$$

where T_R is the reference design life ($T_R=100$ years) and T is the actual design life.

λ_4 , that, as said, accounts for vehicle interactions, can be expressed as

$$\lambda_4(l, N_1) = \sqrt[m]{\frac{N_1^*}{N_1} + \sum_i \left[\frac{N_i^*}{N_1} \cdot \left(\frac{\eta_i}{\eta_1} \right)^m \right] + \sum_i \left[\frac{N_{comb}}{N_1} \cdot \left(\frac{\eta_{comb}}{\eta_1} \right)^m \right]}, \quad (34)$$

where N_1 is the lorry flow on the main lane, N_i the lorry flow on the i -th lane, η_i the max

ordinate of the influence surface corresponding to i-th lane, N_i^* the *lonely*, i.e. not interacting, lorry flow on the i-th lane, N_{comb} the number of interacting lorries and η_{comb} the overall ordinate of the influence surface for the "interacting" lanes, being the second summation extended to all relevant combinations of lorries on several lanes. A closed form expression for λ_4 can be derived for two simultaneously loaded lanes, as shown in the following.

The equivalent impact factor φ_{fat} , finally, is the ratio between the damage due to the dynamic stress history and the damage due to the corresponding static stress history

$$\varphi_{fat} = \sqrt[m]{\frac{\sum n_{i,dym} \cdot (\Delta\sigma_{i,dym})^m}{\sum n_{i,stat} \cdot (\Delta\sigma_{i,stat})^m}} \quad (35)$$

In conclusion, said $\Delta\sigma_c$ the detail category, the fatigue assessment reduces to check

$$\Delta\sigma_{eq} = \lambda \cdot \varphi_{fat} \cdot \Delta\sigma_p \leq \Delta\sigma_c \quad (36)$$

6.3 Partial safety factors γ_M

The partial safety factors γ_f , regarding the action aspect, and γ_m , regarding the fatigue resistance aspect, cover uncertainties in the evaluation of loads and stresses as well as fatigue strength scattering.

According to the experience from steel structures, these partial safety factors affecting stress ranges are generally combined in an unique factor $\gamma_M = \gamma_f \cdot \gamma_m$. Beside the material, the numerical value of γ_M depends on the possibility to detect and repair fatigue cracks and on the consequences of fatigue failure.

6.4 Modeling of vehicle interactions

As already mentioned, if vehicle interaction is relevant, stress histories cannot be determined using conventional fatigue models or recorded traffic data, unless appropriate additional information are available.

The achievement of general theoretical results in modelling vehicle interactions could sensibly enlarge the field of application of the fatigue load models and it represents a main objective in the improvement of EN 1991-2.

The probability that several vehicles are running simultaneously on the bridge on the same lane or on several lanes can be found theoretically in the framework of the queuing theory, considering the bridge as a service system, with or without waiting queue, and the stochastic processes as Markov processes .

That allows determining a suitably modified load spectrum, composed by single vehicles or vehicle convoys travelling alone on the bridge, so that the complete stress history results a random assembly of their individual stress histories.

6.4.1 Basic assumptions

Let the load spectrum consisting in a set of q types of lorries and be N_{ij} the annual flow of the i-th

vehicle on the j -th lane. The total flow on the j -th lane is then $N_j = \sum_{i=1}^q N_{ij}$.

Obviously, as the characteristic length L of the influence line increases, the probability that several lorries are simultaneously travelling on the bridges becomes more and more relevant. Basic hypotheses of the theory are that the vehicle arrivals are distributed according a Poisson law and that the transit time Θ on L is exponentially distributed.

6.4.2 Interaction between lorries simultaneously travelling on one lane

The probability P_n that n lorries are simultaneously travelling on L can be calculated considering the bridge as a single channel system with a waiting queue, in which the waiting time, depending on the number of requests in the queue, and the number of the request in the queue itself are limited. In fact, as there is a minimum value for the time interval T_s between two consecutive lorries, the waiting time for the i -th vehicle in queue is given by $T_i = \Theta - i \cdot T_s$ and the number of requests in queue is limited to $w = \text{int}(\Theta \cdot T_s^{-1}) - 1$.

Under the assumption that each T_i is distributed with an exponential law whose parameter is $\varphi_i = T_i^{-1}$, the problem can be solved in a closed form [18]. The probability P_n to have n vehicles on the lane, i.e. $n-1$ requests in queue, is then given by

$$P_n = \left(\frac{\delta}{\alpha}\right)^n \cdot \left\{ 1 + \frac{\delta}{\alpha} + \sum_{i=2}^w \left[\delta^i \cdot \left(\alpha \cdot \prod_{s=1}^{i-1} \left(\alpha + \sum_{j=1}^s \varphi_j \right) \right)^{-1} \right] \right\}^{-1}, \text{ for } n=0, 1, \quad (37)$$

and by

$$P_n = \left\{ \frac{\delta^n}{\alpha} \cdot \left[\prod_{s=1}^{n-1} \left(\alpha + \sum_{j=1}^s \varphi_j \right) \right]^{-1} \right\} \cdot \left\{ 1 + \frac{\delta}{\alpha} + \sum_{i=2}^w \left[\delta^i \cdot \left(\alpha \cdot \prod_{s=1}^{i-1} \left(\alpha + \sum_{j=1}^s \varphi_j \right) \right)^{-1} \right] \right\}^{-1}, \quad 2 \leq n \leq w, \quad (38)$$

where δ represents the lorry flow density and $\alpha = \Theta^{-1}$. The annual number of interactions between n vehicles i_1, \dots, i_n on the j -th lane can be then obtained substituting these formulae in the general expression,

$$N_{(i_1, i_2, \dots, i_n), j} = \frac{P_n}{1 - P_0} \cdot \frac{N_j}{n} \cdot \frac{\prod_{k=1}^n N_{i_k j}}{\sum_{q^n} \left(\prod_{s=1}^n N_{i_s j} \right)} \quad (39)$$

where \sum_{q^n} indicates the sum over all the possible choices with repetitions of n elements among

q .

In the practice, the problem is reduced to consider the simultaneous presence of two lorries r and t only, so that it results

$$P_0 = \left[1 + \frac{\delta}{\alpha} \cdot \left(1 + \frac{\delta}{\alpha + \varphi_1} \right) \right]^{-1}, \quad P_2 = \frac{\delta^2}{\alpha \cdot (\alpha + \varphi_1)} \cdot \left[1 + \frac{\delta}{\alpha} \cdot \left(1 + \frac{\delta}{\alpha + \varphi_1} \right) \right]^{-1} \quad (40)$$

and the annual number of interactions becomes

$$N_{(r,t),j} = \frac{N_{rj} \cdot N_{tj} \cdot \delta}{(\delta + \alpha + \varphi_1) \cdot \sum_{q^2} \left(\prod_{s=1}^2 N_{i_{ts},j} \right)} \cdot \frac{N_j}{2}. \quad (41)$$

When a single vehicle model is given, expression (41) simplifies further into

$$N_{(1,1),j} = \frac{N_j \cdot \delta}{2 \cdot (\delta + \alpha + \varphi_1)}. \quad (42)$$

6.4.3 Interaction between lorries simultaneously travelling on several lanes

Under the aforementioned hypotheses, interactions between lorries simultaneously travelling on several lanes can be tackled in analogous way considering the bridge as a multiple channel system without waiting queue, where new requests are refused if all channels are occupied. In this case the probability P_k to have simultaneously vehicles on k lanes, i.e. k occupied channels, can be deduced solving an Erlang type system.

Said μ the density of the total flow N^* and recalling that $\alpha = \Theta^{-1}$, it results

$$P_k = \frac{\mu^k}{\alpha^k \cdot k!} \cdot \left(\sum_{i=0}^m \frac{\mu^i}{\alpha^i \cdot i!} \right)^{-1} \quad 0 \leq k \leq m. \quad (43)$$

Substituting (43) in the general expression

$$N_{i_1 h_1, i_2 h_2, \dots, i_k h_k} = \frac{P_k}{1 - P_0} \cdot \left(\prod_{j=1}^k \frac{N_{i_j h_j}}{N_{h_j}} \right) \cdot \frac{N^*}{k} \cdot \frac{\prod_{j=1}^k N_{h_j}}{\sum_{\binom{m}{k}} \left(\prod_{s=1}^k N_{h_{t_s}} \right)} \quad (44)$$

where $\sum_{\binom{m}{k}}$ represents the sum over all the possible choices of k elements among m , it is possible

to derive the annual number of interactions of k lorries, i_1 on the h_1 -th lane, ..., i_k on the h_k -th lane,

$$N_{i_1 h_1, i_2 h_2, \dots, i_k h_k} = \frac{\mu^k}{\alpha^k \cdot k!} \cdot \left(\prod_{j=1}^k \frac{N_{i_j h_j}}{N_{h_j}} \right) \cdot \frac{N^*}{k} \cdot \frac{\prod_{j=1}^k N_{h_j}}{\sum_{\binom{m}{k}} \left(\prod_{s=1}^k N_{h_{t_s}} \right)}. \quad (45)$$

As said before, usually only the case in which two lorries r and t are simultaneously present on the h -th and the j -th lane is relevant, so that it results

$$P_2 = \frac{\mu^2}{2 \cdot \alpha^2} \cdot \left(\sum_{i=0}^2 \frac{\mu^i}{\alpha^i \cdot i!} \right)^{-1} \quad \text{and} \quad N_{r,h,t,j} = \frac{N_{rh} \cdot N_{tj}}{N_h \cdot N_j} \cdot \frac{\mu^2}{2 \cdot \alpha^2} \cdot \left(\sum_{i=1}^2 \frac{\mu^i}{\alpha^i \cdot i!} \right)^{-1} \cdot \frac{N_h + N_j}{2}, \quad (46)$$

or, simply, when a single vehicle is considered,

$$N_{h,j} = \frac{\mu^2}{2 \cdot \alpha^2} \cdot \left(\sum_{i=1}^2 \frac{\mu^i}{\alpha^i \cdot i!} \right)^{-1} \cdot \frac{N_h + N_j}{2}. \quad (47)$$

6.4.4 The time independent load spectrum

The procedures described above allow to obtain so the above mentioned *lonely vehicles spectrum*, which is time-independent being composed by individual vehicles and by vehicle convoys travelling alone on the bridge.

Generally, the evaluation of the lonely vehicles spectrum requires to apply both procedures: the simultaneous transit on the same lane is considered first, in order to obtain for each lane a new load spectrum, composed by individual vehicles and by vehicle convoys travelling alone on the lane, to be used to solve the multilane case.

6.4.5 Time independent interactions

Once the *lonely* vehicle spectrum is determined, the complete stress history can be derived as a random assembly of the individual stress histories.

Unfortunately, the stress spectrum cannot be determined, in general, as a pure and simple sum of the individual stress spectra. In fact when maximum and minimum stresses are given by different members of the spectrum, the individual stress histories can combine, depending on the cycle counting method adopted, originating some kind of time independent interaction.

If cycles are identified using the reservoir method or the rainflow method, the problem can be solved in the general case. The demonstration is out of the scope of this Handbook and it will show only the main results.

Two individual stress histories σ_{A_i} and σ_{A_j} interact if and only if

$$\max \sigma_{A_i} \leq \max \sigma_{A_j} \text{ and } \min \sigma_{A_i} \leq \min \sigma_{A_j} \quad (48)$$

or

$$\max \sigma_{A_j} \leq \max \sigma_{A_i} \text{ and } \min \sigma_{A_j} \leq \min \sigma_{A_i} . \quad (49)$$

If the couples of interacting histories are sorted in such a way that the corresponding $\Delta\sigma_{\max}$ are in descending order, the number of the combined stress histories as well as the residual numbers of each individual stress history can be computed in a very simple recursive way.

In general, an individual stress history can interact with several others; therefore the number of combined stress histories N_{cij} , obtained as h-th combination of the stress history σ_{A_i} and as k-th combination of the stress history σ_{A_j} is given by

$$N_{cij} = \frac{{}^{(h-1)}N_i \cdot {}^{(k-1)}N_j}{{}^{(h-1)}N_i + {}^{(k-1)}N_j} , \quad (50)$$

where ${}^{(h-1)}N_i$ and ${}^{(k-1)}N_j$ are the number of the individual stress histories σ_{A_i} and σ_{A_j} not yet combined and being ${}^{(0)}N_i = N_{A_i}$ and ${}^{(0)}N_j = N_{A_j}$ the number of repetitions of σ_{A_i} and σ_{A_j} in the lonely vehicle spectrum. The actual number of individual stress histories σ_{A_i} , which do not combine with other stress histories, is given by

$${}^{(p)}N_i = {}^{(0)}N_i - \sum_{k \neq i} (N_{ik} + N_{ki}) , \quad (51)$$

being the sum extended to all the stress histories σ_{A_k} , which combine with σ_{A_i} itself.

In conclusion, a new modified load spectrum is obtained, whose members, represented by the lonely individual vehicles and convoys and by their time independent combinations, are

interaction free, so that it can be defined as interaction-free vehicle spectrum.

6.4.6 Some relevant results

The above mentioned method allows the derivation of some important general results. In fact it can be used to tackle relevant questions concerning the calculation of the maximum length of the influence line for which lorry interaction on the same lane can be disregarded or with the calibration of λ_4 -factor accounting for multilane effect in λ -coefficient method.

The analysis, shortly illustrated below, has been performed on the basis of the following assumption:

- linear S-N curve having slope $m=5$;
- four different annual lorry flow rates, $N_1=2.5 \times 10^5$; $N_2=5.0 \times 10^5$; $N_3=1.0 \times 10^6$; $N_4=2.0 \times 10^6$, distributed over 280 working days;
- constant lorry speed $v=13.889$ m/sec.

Assuming an inter-vehicle interval $T_s=1.5$ sec, application of (42) allows for example, the determination of how many vehicles per years are travelling simultaneously on the same lane, depending on the annual flow and on the considered length L , as summarised in table 18.

L (m)	N_1	N_2	N_3	N_4
40	1190	4729	18566	71605
50	1690	6670	25987	98813
60	2165	8515	32940	123618
75	2858	11177	42796	157689
100	3978	15423	58110	208240

Table 18. Number of yearly interacting vehicles in one lane for different flows and spans

These theoretical results, which are in good agreement with numerical simulations, confirm that simultaneous presence of several lorries on the same lane is generally not relevant for spans below 75 m. On the contrary, when bending moment on support of two span continuous beams is considered under high traffic flows, simultaneity results significant starting from 30 m span.

Closed form expression of λ_4 coefficient can be obtained in a particularly relevant case, resorting to formula (47).

If two lanes carrying the same lorry flow are considered, a number of interacting vehicles per year comes out according to table 19. Starting from table 19, an equivalent stress range $\Delta\sigma_{eq}$, taking into account the interactions as well as all possible relative positions of the two lorries, can be easily evaluated, provided that the influence coefficient of each lane is known. If $\Delta\sigma_1$ is the equivalent stress range induced by one lane flow only the required λ_4 coefficient is simply given by $\Delta\sigma_{eq}/\Delta\sigma_1$.

If the two lanes have the same “weight”, i.e. the influence surface is cylindrical, λ_4 values are in accordance with table 20, being $1.149 \approx \sqrt[3]{2}$ the basic value for λ_4 , corresponding to zero interactions.

These results demonstrate that λ_4 , allowing to take into account in a simplified manner the global vehicle interactions, is a quasi-linear function of $\Theta \cdot N$, which can be expressed in closed form as

$$\lambda_4 = \sqrt[5]{\frac{\eta_1 + \eta_2}{\eta_1}} \cdot \left(1.03 + 0.01 \cdot \frac{L \cdot N}{v \cdot 10^6} \right), \quad (52)$$

where L is in m and v in m/sec, being η_1 and η_2 , $\eta_1 \geq \eta_2$, the influence coefficients of the two lanes, respectively.

L (m)	N_1	N_2	N_3	N_4
10	1846	7331	28901	112358
20	3666	14450	56179	212764
30	5458	21367	81966	303028
50	8967	34626	129532	458712
75	13213	50200	182480	617280
100	17312	64766	229356	746264
150	25100	91240	308640	943390
200	32383	114678	373132	1086953

Table 19. Number of yearly interacting vehicles on two lanes for different flows and spans

L (m)	N_1	N_2	N_3	N_4
10	1.156	1.162	1.174	1.197
20	1.162	1.174	1.197	1.234
30	1.168	1.186	1.217	1.264
50	1.180	1.207	1.250	1.310
75	1.194	1.230	1.283	1.351
100	1.207	1.250	1.310	1.381
150	1.230	1.283	1.351	1.423
200	1.250	1.310	1.381	1.450

Table 20. λ_4 -factors for two-lane interactions for different flows and spans considering cylindrical influence surfaces

7 ACTIONS ON FOOTBRIDGES

7.1 Field of application

The EN1991-2 section concerning actions on footbridges covers explicitly actions on footways, cycle tracks and footbridges and it is specially devoted only to footbridges. The uniformly distributed load q_{fk} and the concentrated load Q_{fwk} given below, where relevant can be also used for parts of road and railway bridges accessible to pedestrian.

Load models and their representative values include dynamic amplification effects and should be used for all kind of serviceability and ultimate limit state static calculations, excluding fatigue limit states.

When vibration assessments based on specific dynamic analysis are necessary, ad hoc studies should be performed. Some guidance about vibration check of footbridges is given in EN1990-A2 as summarized in clause 7.6 of this Handbook

7.2 Vertical load models

Three different vertical load models can be envisaged for footbridges:

1. an uniformly distributed load representing the static effects of a dense crowd;
2. one concentrated load, representing the effect of a maintenance load;
3. one or more, mutually exclusive, standard vehicles, to be taken into account when maintenance or emergency vehicles are expected to cross the footbridge itself.

7.2.1 Uniformly distributed loads

The crowd effect on the bridge is represented by a uniformly distributed load.

When risk of dense crowd exists or when specified for a particular project, Load Model 4 for road bridges should be considered also for footbridges.

On the contrary, where the application of the aforesaid Load Model 4 is not required, a uniformly distributed load, to be applied to the unfavourable parts of the influence surface longitudinally and transversally, q_{fk} should be defined in the National Annex.

The recommended value, depending on the loaded length L [m] is:

$$2,5 \text{ kN/m}^2 \leq q_{fk} = 2,0 + \frac{120}{L + 30} \leq 5,0 \text{ kN/m}^2, \quad (53)$$

For road bridges supporting footways or cycle tracks, only the characteristic values (5 kN/m^2) or the combination value ($2,5 \text{ kN/m}^2$) should be considered, according to figure 34.

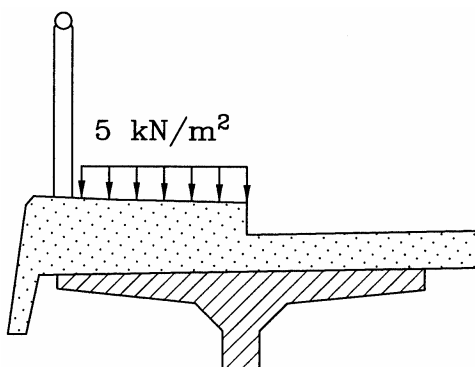


Figure 34. Characteristic load on a footway (or cycle track) of a road bridge

7.2.2 Concentrated load

For local effect assessment, a 10 kN concentrated load $Q_{f_{wk}}$, representing a maintenance load, should be considered on the bridge, acting on a square surface of sides 10 cm.

When the service vehicle described in 7.2.3 is taken into account, $Q_{f_{wk}}$ should be disregarded.

The concentrated load $Q_{f_{wk}}$ should not be combined with any other variable non-traffic load.

7.2.3 Service vehicle

When service vehicles for maintenance, emergencies (*e.g.* ambulance, fire) or other services must be considered, they should be assigned for the particular project. If no information is available and if no permanent obstacle prevents a vehicle being driven onto the bridge deck, the special vehicle defined in figure 35 should be considered.

If consideration of the service vehicle is not requested the vehicle shown in figure 35 should be considered as accidental.

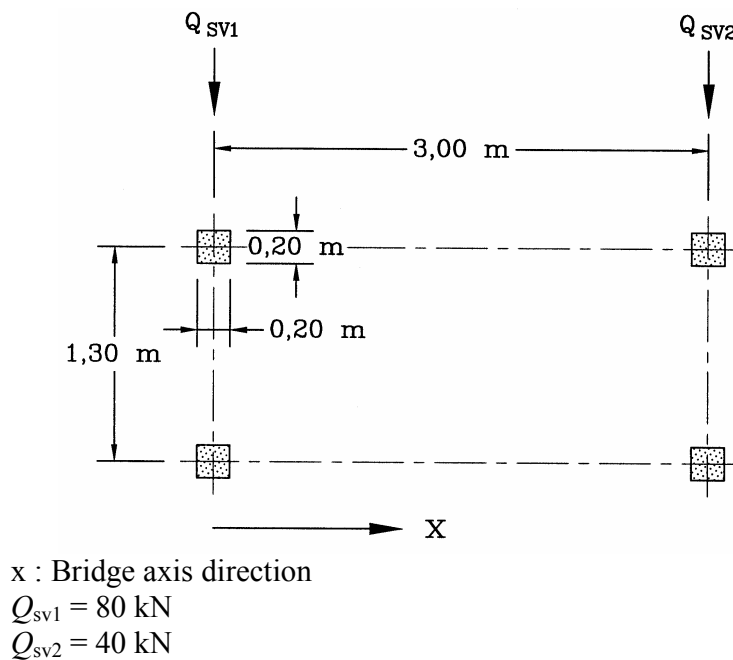


Figure 35. Service or Accidental vehicle

7.3 Horizontal forces - characteristic values

A horizontal force Q_{fk} acting along the bridge deck axis at the pavement level should be taken into account for footbridges only, whose characteristic value is equal to the greater of these two values:

- 10 per cent of the total load corresponding to the uniformly distributed load or
- 60 per cent of the total weight of the service vehicle, when relevant.

should be considered on the bridge, acting on a square surface of sides 10 cm.

This horizontal force, which is normally sufficient to ensure the horizontal longitudinal stability of the footbridge, is assumed to act simultaneously with the corresponding vertical load, and in no case with the concentrated load Q_{fwk} .

7.4 Groups of traffic loads on footbridges

Vertical loads and horizontal forces due to traffic should be combined, when relevant, taking into account the groups of loads defined in Table 21. Each of these groups of loads, which are mutually exclusive, should be considered as defining a characteristic action for combination with non – traffic loads.

<i>Load type</i>		<i>Vertical forces</i>		<i>Horizontal forces</i>
<i>Load system</i>		<i>Uniformly distributed load</i>	<i>Service vehicle</i>	
<i>Groups of loads</i>	<i>gr1</i>	F_k	0	F_k
	<i>gr2</i>	0	F_k	F_k

Table 21. Definition of groups of loads (characteristic values)

As a rule, expect for roofed bridges, where appropriate rules are defined in EN 1991-1-3, traffic loads on footbridges are considered not to act simultaneously with significant wind or snow. Wind and thermal actions should not be taken into account as simultaneous. When combination of traffic loads together with actions specified in other Parts of EN 1991 must be considered, any group of loads in table 21 should be considered as one action.

7.5 Application of the load models

The traffic models described above with the exception of the service vehicle model, may also be used for pedestrian and cycle traffic on the areas of the deck of road bridges limited by parapets and not included in the carriageway, or on the footpaths of railway bridges. These actions are free, so that the models of vertical loads should be applied anywhere within the relevant areas in such a way that the most adverse effect is obtained.

7.6 Verifications regarding traffic induced deformations and vibrations for footbridges

Deformations and vibrations induced by the traffic strongly influence the serviceability level of footbridges.

Relevant types of vibrations of the main structure to be identified and taken into account are vertical and horizontal vibrations, as well as torsional vibrations, either alone or coupled with vertical and/or horizontal vibrations

The design situations to be studied depend on the pedestrian traffic admitted on individual footbridges during their design working life and on how they will be authorised, regulated and controlled.

Design situations should include:

1. the simultaneous presence of a group of about 8 to 15 persons walking normally as a persistent design situation;
2. the simultaneous presence of streams of pedestrians (significantly more than 15 persons), which could be persistent, transient or accidental depending on *boundary conditions*, like

location of the footbridge in urban or rural areas, the possibility of crowding due to the vicinity of railway and bus stations, schools, important building with public admittance, the relevance of the footbridge itself;

3. occasional sports, festive or choreographic events, which require specific studies.

7.6.1. Bridge-traffic interaction

Periodic forces exert by a pedestrian normally walking are

- vertical, with a frequency ranging between 1 and 3 Hz, and
- horizontal, with a frequency ranging between 0,5 and 1,5 Hz, perfectly synchronised with the vertical ones.

Obviously, the forces exerted by several persons are usually not synchronised and characterised by different frequencies.

When the frequency of the forces normally exerted by pedestrians is close to a natural frequency of the deck, it commonly happens that the subjective perception of the bridge oscillation induces the pedestrian to synchronise their steps with the vibrations of the bridge, so that resonance occurs, increasing considerably the response of the bridge.

It must be stressed that the number of persons participating to the resonance is highly random ; beyond about 10 persons on the bridge, it is a decreasing function of their number. The resonance is in most cases mainly, but not solely, marked with the fundamental frequency of the bridge. Correlation between forces exerted by pedestrians may increase with movements.

7.6.2. Dynamic models of pedestrian loads

Two separate dynamic models of pedestrian loads for the design of footbridges could be defined:

1. a concentrated force (F_n), representing the excitation by a limited group of pedestrians, which should be systematically used for the verification of the comfort criteria;
2. a uniformly distributed load (F_s), representing the excitation by a continuous stream of pedestrians, which should be used also where specified, separately from F_n .

Load model F_n , which should be placed in the most adverse position on the bridge deck, consists in one pulsating force (N) with a vertical component $F_{n,v} = 280k_v(f_v)\sin(2\pi f_v t)$ and an horizontal component $F_{n,h} = 70k_h(f_h)\sin(2\pi f_h t)$, where f_v is the natural vertical frequency of the bridge closest to 2 Hz, f_h is the natural horizontal frequency of the bridge closest to 1 Hz, t is the time in s and $k_v(f_v)$ and $k_h(f_h)$ are suitable coefficients, depending on the frequency, given in Figure 36.

The two components $F_{n,v}$ and $F_{n,h}$ should be considered separately.

When inertia effects are evaluated as well as for the calculation of f_v or f_h , F_n should be associated with a static mass equal to 800 kg (if unfavourable), applied at the same location.

The uniformly distributed load model F_s , to be applied on the whole deck of the bridge, consists in a uniformly distributed pulsating load (N/m^2) with a vertical component, $F_{s,v} = 15k_v(f_v)\sin(2\pi f_v t)$ and an horizontal component, $F_{s,h} = 4k_h(f_h)\sin(2\pi f_h t)$ to be considered separately.

When inertia effects are evaluated as well as for the calculation of f_v or f_h , F_s should be associated with a static mass equal to 400 kg/m² (if unfavourable), applied at the same location.

For particular project, especially for big footbridges, it may be possible to increase the reliability degree of the assessments, by specifying to apply F_s on limited unfavourable areas (e.g. span by

span) or with an opposition of phases on successive spans.

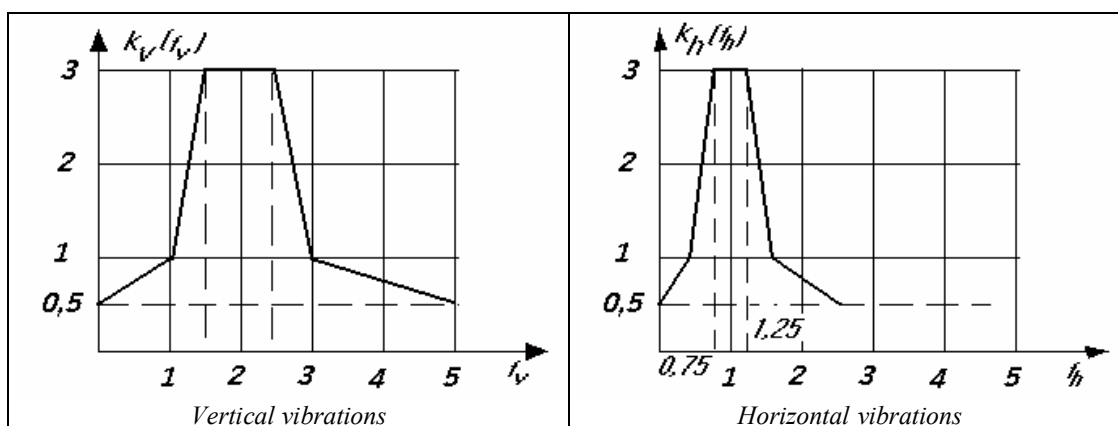


Figure 36. Relationships between coefficients $k_v(f_v)$, $k_h(f_h)$ and frequencies f_v , f_h

7.6.2. Comfort criteria

In order to ensure pedestrian comfort, the maximum acceleration of any part of the deck should not exceed

- 0,7 (m/s² for vertical vibrations; or
- 0,15 (m/s²) for horizontal vibrations.

The assessment of comfort criteria should be performed when the natural vertical frequency is less than 5 Hz or the horizontal and torsional natural frequencies are less than 2.5 Hz.

The assessment of natural frequencies f_v or f_h should take into account the mass of any permanent load. The mass of pedestrians should be taken into account only for very light decks. The stiffness parameters of the deck should be based on the short term dynamic elastic properties of the structural material and, if significant, of the parapets.

When comfort criteria do not seem to be satisfied with a significant margin, it is recommended to make provision in the design for the possible installation of dampers in the structure after its completion.

Evaluation of accelerations shall take into account the damping of the footbridge, through the *damping factor* ζ referring to the critical damping, or the *logarithmic decrement* δ , which is equal to $2\pi\zeta$.

For rather short spans, when calculations are performed using the groups of pedestrians given before, the acceleration can be reduced multiplying it by :

- $k_{n,v} = 1 - \exp(-2\pi n\zeta)$ for vertical vibrations or by
- $k_{n,h} = 1 - \exp(-\pi n\zeta)$ for horizontal vibrations, being

n , equal to 12 times is the number of steps necessary to cross the span under consideration.

For a simple span, the design value of the vertical acceleration (m/s²) due to the group of pedestrians may then be taken as equal to :

$$a_{ld} = 165k_v(f_v) \frac{1 - \exp(-2\pi n\zeta)}{M\zeta}, \text{ where} \quad (54)$$

M is the total mass of the span, f is the relevant, i.e. the determining, fundamental frequency, and $k_v(f_v)$ is given in figure 36.

7.7 Load combinations for footbridges

The load combination coefficients ψ for footbridges are given in table 22, where traffic loads refer to table 21.

Action	Symbol	ψ_0	ψ_1	ψ_2
Traffic loads (see table 21)	gr1	0.40	0.40	0
	Q_{fk}	0	0	0
	gr2	0	0	0
Wind forces	F_{wk}	0.3	0.2	0
Thermal Actions	T_k	0.6 ⁽¹⁾	0.6	0.5
Snow loads	$Q_{sn,k}$ (during execution)	0.8	-	0
Construction loads	Q_c	1.0	-	0
<i>(1) The recommended ψ_0 value for thermal actions may in most cases be reduced to 0 for ultimate limit states EQU, STR and GEO. See also the design Eurocodes</i>				

Table 22. Recommended values of ψ - factors for footbridges

8 ACTIONS ON RAILWAY BRIDGES

Even though the weight and geometry of trains is exactly known, as for bridges the railway bridges load models do not describe actual loads. They have been selected in such a way that their effects, within the dynamic increments, which are taken into account separately, in this case, represent the effects of service traffic in the European railways network.

Of course, when other traffic conditions outside the scope of the load models specified in EN 1991-2 needs to be considered, then specific alternative load models and associated combination should be defined in the National Annex or specified by the Client.

The rail traffic within the scope in EN1991-2 concerns standard track gauge and wide track gauge European mainline network, so that the load models given below are not applicable to narrow-gauge railways, tramways and other light railways, preservation railways, rack and pinion railways, funicular railways, which require specific loading models.

8.1 Representation of actions and nature of rail traffic loads

In EN 1991-2 the following actions due to normal railway operations are considered:

- vertical loads,
 - vertical loading for earthworks,
 - dynamic effects,
 - centrifugal forces,
 - nosing forces,
 - traction and braking forces,
 - combined response of a structure and track to variable actions,
 - aerodynamic effects from passing trains,
 - actions due to overhead line equipment and other railway infrastructure and equipment.
- Accidental actions are given for the effect of rail traffic derailment on a structure carrying rail traffic.

8.2 Vertical loads

Five load models are given in EN 1991-2 for railway loading:

- 1 Load Model 71 represent normal rail traffic on mainline railways;
- 2 Load Model SW/0, which could be relevant for continuous bridges,
- 3 Load Model SW/2 to represent heavy loads,
- 4 Load Model HSLM represent high speed (>200 km/h) passenger trains;
- 5 Load Model “unloaded train” to represent the effect of an unloaded train.

The specified loading given in the following clauses can be varied depending on the nature, volume and maximum weight of rail traffic on different railways, as well as different qualities of track.

8.2.1 Load Model 71

Load Model 71, representing the static effect of vertical loading due to normal rail traffic, is composed by a 4-axles vehicle weighing 1000 kN and by a uniformly distributed loads equal to 80kN/m, not limited extension, as illustrated in figure 37.

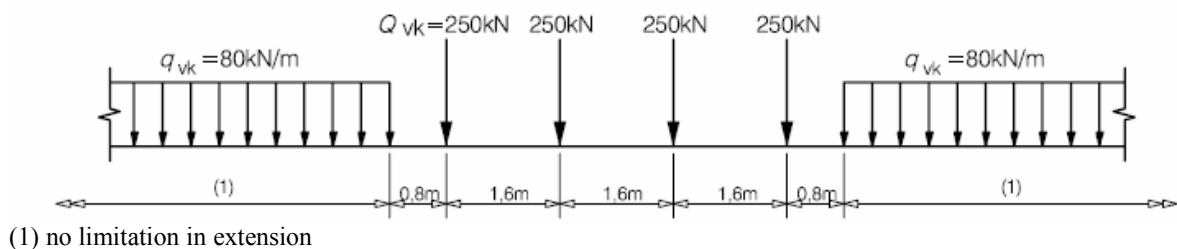


Figure 37. Load Model 71

On lines carrying rail traffic which is heavier or lighter than normal rail traffic, the characteristic values given in figure 37 should be classified, i.e. multiplied by a factor α , which should be one of the following values: 0,75 - 0,83 - 0,91 - 1,00 - 1,10 - 1,21 - 1,33 – 1.46

When values are classified, equivalent vertical loading for earthworks and earth pressure effects, centrifugal , traction and braking forces, combined response of structure and track to variable actions, accidental actions and Load Model SW/0 for continuous span bridges should also be multiplied for the same factor α .

8.2.2 Load Models SW/0 and SW/2

Load Model SW/0 represents the static effect of normal rail traffic on continuous beams.

Load Model SW/2 represents the static effect of heavy rail traffic and it should be taken into account for lines or section of line where heavy rail traffic is foreseen.

Load models SW/0 and SW/2 are represented by two unlimited uniformly distributed loads, suitably spaced, by a distance c as illustrated in figure 38. Load values are given in table 23.

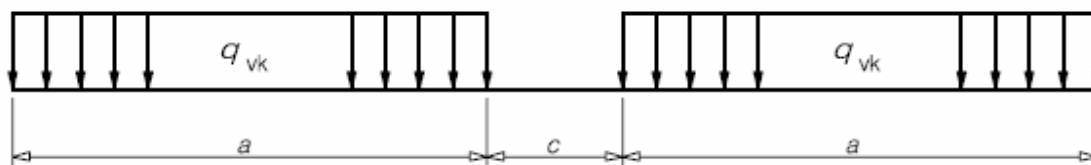


Figure 38. Load Models SW/0 and SW/2

Load Model	q_{vk} [kN/m]	a [m]	c [m]
SW/0	133	15,0	5,3
SW/2	150	25,0	7,0

Table 23. Characteristic values for vertical loads for Load Models SW/0 and SW/2

8.2.3. Load Model “unloaded train”

The so called *unloaded train* is a particular load model consisting of a vertical uniformly distributed load with a characteristic value of 10,0 kN/m, which could be used for some particular verifications.

8.2.4 Eccentricity of vertical load models 71 and SW/0

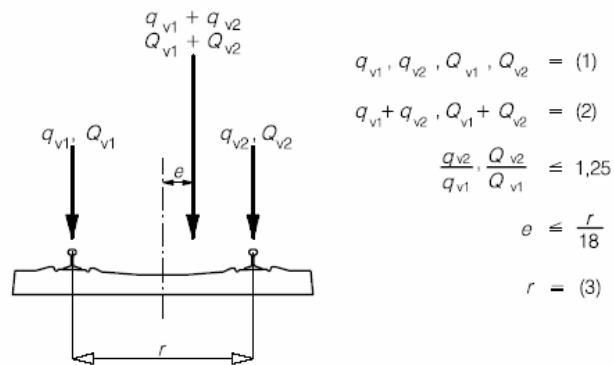
For static assessments, the eccentricity of vertical load due to lateral displacement is considered by taking the ratio of wheel loads on all axles as up to 1,25:1,00 on any one track, so that it results the eccentricity e shown in figure 39.

In fatigue verifications, the eccentricity of vertical loads may be neglected.

8.2.5 Distribution of axle loads

Distribution of axle loads by the rails, sleepers and ballast, for all kind of trains and verifications, including fatigue, can be taken into account as indicated in the following.

- *Longitudinal distribution*: a point force or an axle load is distributed by the rail over three adjacent sleepers so that the 50% of the load is transmitted by the loaded sleeper and the 25% of the load is transmitted by each one of the sleepers adjacent to the loaded one as indicated in figure 40; for local verifications a load dispersal with 4:1 slope through the ballast can be considered according to figure 41.



- (1) Uniformly distributed load and point loads on each rail as appropriate
- (2) LM 71 (and SW/0 where required)
- (3) Transverse distance between wheel loads

Figure 39. Eccentricity of vertical loads

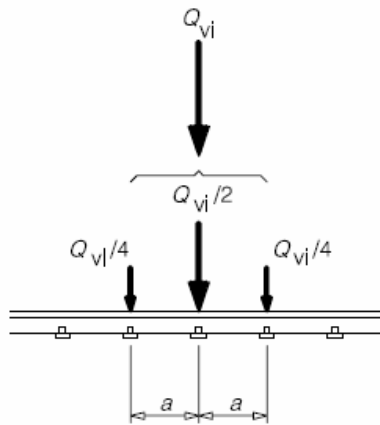


Figure 40. Longitudinal distribution of concentrated loads

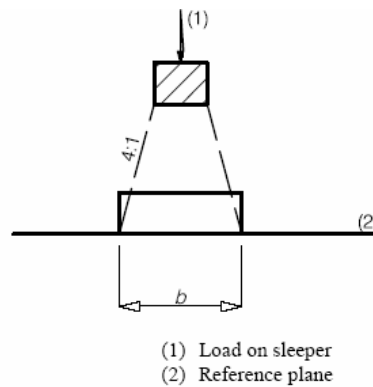


Figure 41. Longitudinal dispersal of sleeper loads through the ballast

- *Trasversal distribution:* This depends on the track configuration. For bridges with ballasted track without cant, the actions should be distributed transversely as shown in figure 42; for full length sleepers, where the ballast is only consolidated under the rails, or for duo-block sleepers, the actions should be distributed transversely as shown in figure 43; for bridges

with ballasted tracks with cant the actions should be distributed transversely as shown in figure 44 and finally, on bridges with ballasted track and cant and for full length sleepers, where the ballast is only consolidated under the rails, or for duo-block sleepers, figure 44 should be modified to take into account the transverse load distribution under each rail shown in figure 43.

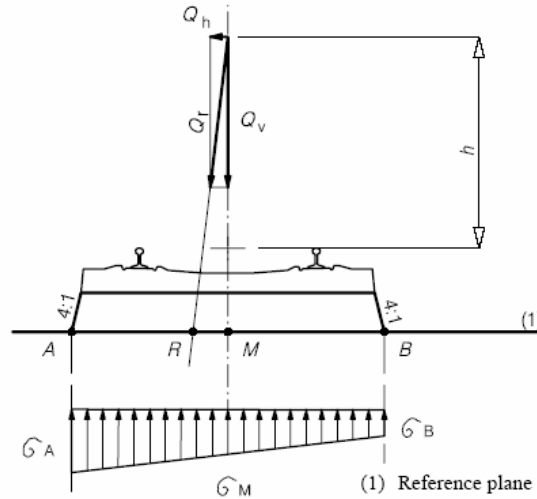


Figure 42. Transverse distribution of action for ballasted tracks without cant

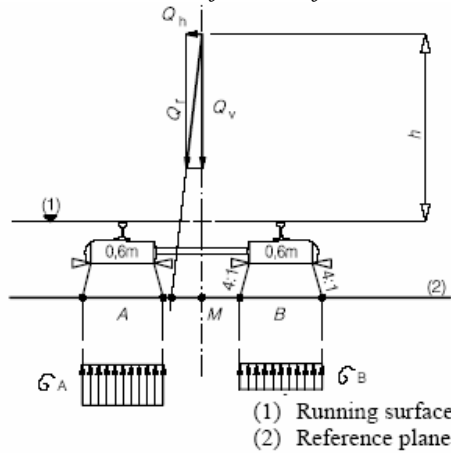


Figure 43. Transverse distribution of action for duo-block sleepers

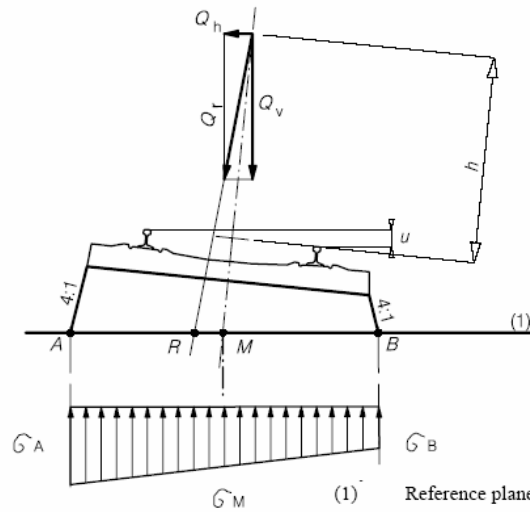


Figure 44. Transverse distribution of action for ballasted tracks with cant

8.2.6 Equivalent vertical loading for earthworks and earth pressure effects

For the evaluation of global effects, the characteristic vertical loading due to rail traffic actions for earthworks under or adjacent to the track may be taken as the appropriate load model LM71 or SW/2 uniformly distributed over a width of 3,00 m at a level 0,70 m below the running surface of the track. Dynamic effects can be disregarded.

For local elements close to a track (e.g. ballast retention walls and so on), the maximum local vertical, longitudinal and transverse loadings on the element due to rail traffic actions should be evaluated.

8.2.7 Footpaths and general maintenance loading

Pedestrian, cycle and general maintenance loads should be represented by a uniformly distributed load with a characteristic value $q_{rk} = 5 \text{ kN/m}^2$, while for design of local elements a concentrated load $Q_k = 2,0 \text{ kN}$ acting alone should be applied on a square surface with a 200 mm side.

8.3 Dynamic magnification factors Φ (Φ_2 , Φ_3)

Dynamic magnification of stresses and vibration effects is taken into account through the dynamic factor Φ , provided that risks of resonance effects and excessive vibrations of the bridge are negligible.

When risks of resonance or excessive vibrations exist a suitable dynamic analysis should be carried out. Quasi static methods which use static load effects multiplied by the dynamic factor Φ are unable to predict resonance effects from high speed trains: in this case, dynamic analysis techniques, taking into account the time dependant nature of the loading from the High Speed Load Model (HSLM) and Real Trains (e.g. by solving equations of motion) are required for predicting dynamic effects at resonance.

The dynamic factors apply also to structures with more than one track.

8.3.1. Definition of the dynamic factor Φ

The dynamic factor Φ which increases the static load effects induced by Load Models 71, SW/0 and SW/2 should be taken as Φ_2 or Φ_3 , according to the level of maintenance of tracks.

For carefully maintained track, it is

$$\Phi_2 = \frac{1,44}{\sqrt{L_\Phi} - 0,2} + 0,82, \text{ with } 1,00 \leq \Phi_2 \leq 1,67, \quad (55)$$

while for standard maintained track, it is

$$\Phi_3 = \frac{2,16}{\sqrt{L_\Phi} - 0,2} + 0,73, \text{ with } 1,00 \leq \Phi_3 \leq 2,00, \quad (56)$$

being L_Φ the “determinant” length associated with Φ in [m], as defined in table 24. When no values of L_Φ are specified, it should be taken as the length of the influence line for deflection of the element being considered.

The dynamic factor Φ shall not be used with the loading due to Real Trains, loading due to Fatigue Trains, Load Model HSLM and load model “unloaded train”.

When the resultant stress in a structural member depends on several effects, each of which relates to a separate structural behaviour, each effect should be calculated using the appropriate determinant length.

Case	Structural element	Determinant length L_Φ
Steel deck plate: closed deck with ballast bed (orthotropic deck plate) (for local and transverse stresses)		
Deck with cross girders and continuous longitudinal ribs:		
1.1	Deck plate (for both directions)	3 times cross girder spacing
1.2	Continuous longitudinal ribs (including small cantilevers up to 0,50 m) ^a	3 times cross girder spacing
1.3	Cross girders	Twice the length of the cross girder
1.4	End cross girders	3,6m ^b
Deck plate with cross girders only:		
2.1	Deck plate (for both directions)	Twice cross girder spacing + 3 m
2.2	Cross girders	Twice cross girder spacing + 3 m
2.3	End cross girders	3,6m ^b
Steel grillage: open deck without ballast bed^b (for local and transverse stresses)		
3.1 Rail bearers:		
	- as an element of a continuous grillage	3 times cross girder spacing
	- simply supported	Cross girder spacing + 3 m
3.2	Cantilever of rail bearer ^a	3,6m
3.3	Cross girders (as part of cross girder/ continuous rail bearer grillage)	Twice the length of the cross girder
3.4	End cross girders	3,6m ^b
^a In general all cantilevers greater than 0,50 m supporting rail traffic actions need a special study		
^b It is recommended to apply Φ_3		

Table 24.a. Determinant length L_Φ

For arch bridges and concrete bridges of all types with a cover of more than 1,00 m, Φ_2 and Φ_3 may be reduced as follows:

$$\text{red } \Phi_{2,3} = \Phi_{2,3} - \frac{h - 1,00}{10} \geq 1,0, \text{ being} \quad (57)$$

h [m] is the height of cover including the ballast from the top of the deck to the top of the sleeper, (for arch bridges, from the crown of the extrados).

The effects of rail traffic actions on columns with a slenderness <30 , abutments, foundations, retaining walls and ground pressures may be calculated without taking into account dynamic effects.

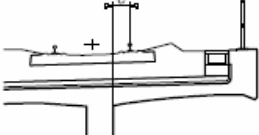
Case	Structural element	Determinant length L_ϕ
Concrete deck slab with ballast bed (for local and transverse stresses)		
4.1	Deck slab as part of box girder or upper flange of main beam - spanning transversely to the main girders - spanning in the longitudinal direction - cross girders - transverse cantilevers supporting railway loading	3 times span of deck plate 3 times span of deck plate Twice the length of the cross girder  - $e \leq 0,5$ m: 3 times the distance between the webs - $e > 0,5$ m: ^a
4.2	Deck slab continuous (in main girder direction) over cross girders	Twice the cross girder spacing
4.3	Deck slab for half through and trough bridges: - spanning perpendicular to the main girders - spanning in the longitudinal direction	Twice span of deck slab + 3m Twice span of deck slab
4.4	Deck slabs spanning transversely between longitudinal steel beams in filler beam decks	Twice the determinant length in the longitudinal direction
4.5	Longitudinal cantilevers of deck slab	- $e \leq 0,5$ m: 3,6m ^b - $e > 0,5$ m: ^a
4.6	End cross girders or trimmer beams	3,6m ^b
^a In general all cantilevers greater than 0,50 m supporting rail traffic actions need a special study ^b It is recommended to apply ϕ_3 NOTE For Cases 1.1 to 4.6 inclusive L_ϕ is subject to a maximum of the determinant length of the main girders.		

Table 24.b. Determinant length L_ϕ

Case	Structural element	Determinant length L_{ϕ}
Main girders		
5.1	Simply supported girders and slabs (including steel beams embedded in concrete)	Span in main girder direction
5.2	Girders and slabs continuous over n spans with $L_m = 1/n (L_1 + L_2 + \dots + L_n)$	$L_{\phi} = k \times L_m$, (6.7) but not less than $\max L_i (i = 1, \dots, n)$ $n = 2 \quad 3 \quad 4 \quad \geq 5$ <hr/> $k = 1,2 \quad 1,3 \quad 1,4 \quad 1,5$
5.3	Portal frames and closed frames or boxes: - single-span - multi-span	Consider as three-span continuous beam (use 5.2, with vertical and horizontal lengths of members of the frame or box) Consider as multi-span continuous beam (use 5.2, with lengths of end vertical members and horizontal members)
5.4	Single arch, archrib, stiffened girders of bowstrings	Half span
5.5	Series of arches with solid spandrels retaining fill	Twice the clear opening
5.6	Suspension bars (in conjunction with stiffening girders)	4 times the longitudinal spacing of the suspension bars
Structural supports		
6	Columns, trestles, bearings, uplift bearings, tension anchors and for the calculation of contact pressures under bearings.	Determinant length of the supported members

Table 24.c. Determinant length L_{ϕ}

8.4 Application of traffic loads on railway bridges

A railway bridge should be designed for the required number and position(s) of the tracks, considering the greatest number of tracks geometrically and structurally possible in the least favourable position, irrespective of the position of the intended tracks, according to the given minimum spacing between centre-lines of adjacent tracks.

The effects of all actions should be determined considering traffic loads and forces should be placed in the most unfavourable positions.

For the determination of the most adverse load effects, Load Model 71 should be applied according to the following rules:

- any number of lengths of the uniformly distributed load q_{vk} should be applied to a track and up to four of the individual concentrated loads Q_{vk} should be applied once per track,
- for elements carrying two tracks, Load Model 71 shall be applied to either track or both tracks,
- for bridges carrying three or more tracks, Load Model 71 shall be applied to any one track, any two tracks or 0,75 times Load Model 71 to three or more of the tracks.

For the determination of the most adverse load effects, Load Model SW/0 should be applied according to the following rules:

- the loading SW/0 should be applied once to a track,
- for elements carrying two tracks, Load Model SW/0 should be applied to either track or both tracks,
- for bridges carrying three or more tracks, Load Model SW/0 should be applied to any one track, any two tracks or 0,75 times Load Model SW/0 to three or more of the tracks;
- continuous beam bridges designed for Load Model 71 shall be checked additionally for Load Model SW/0.

For the determination of the most adverse load effects, Load Model SW/2 should be applied according to the following rules:

- the loading SW/2 shall be applied once to a track,
- for elements carrying more than one track, Load Model SW/2 shall be applied to any one track only with Load Model 71 or Load Model SW/0 applied to the other tracks in accordance with the aforesaid application rules.

For the determination of the most adverse load effects Load Model “unloaded train” should be applied according to the following rules:

- any number of lengths of the uniformly distributed load q_{vk} shall be applied to a track,
- generally Load Model “unloaded train” shall only be considered in the design of structures carrying one track.

Where a dynamic analysis is required the bridges should also be designed for the loading from Real trains and Load Model HSLM, according to the pertinent application rules.

Assessing deformations or vibrations, the vertical loading to be applied should be:

- Load Model 71 and if required Load Models SW/0 and SW/2 increased by the dynamic factor Φ when determining deformations,
- Load Model HSLM or Real Trains when risks of resonance or excessive vibrations exist.

The checks for the limits of deflection and vibration for bridge decks carrying one or more tracks should be made with the number of tracks loaded according to table 25.

8.5 Horizontal forces - characteristic values

8.5.1 Centrifugal forces

The centrifugal force and the track cant should be considered where the track is curved over the whole or part of the length of the bridge.

The centrifugal forces should be taken to act outwards in a horizontal direction at a height of 1,80 m above the running surface, considering the Maximum Line Speed allowed at the Site, except for Load Model SW/2, for which a maximum speed of 80 km/h may be assumed.

The characteristic values Q_{tk} , q_{tk} of the centrifugal forces are

$$Q_{tk} = \frac{v^2}{g \times r} (f \times Q_{vk}) = \frac{V^2}{127 \cdot r} (f \times Q_{vk}) \text{ [kN]} \quad (58)$$

$$q_{tk} = \frac{v^2}{g \times r} (f \times q_{vk}) = \frac{V^2}{127 \cdot r} (f \times q_{vk}) \text{ [kN/m], being}$$

- Q_{vk} and q_{vk} The characteristic values of the vertical loads (excluding any enhancement for dynamic effects) for Load Models 71, SW/0, SW/2 and “unloaded train”;
- f a reduction factor, explained in the following;

Limit State and associated acceptance criteria	Number of tracks loaded		
	1	2	≥ 3
Traffic Safety Checks:			
– Deck twist (EN 1990 Annex 2 A2.4.4.2.2)	1	1 or 2 ^{*)}	1 or 2 or 3 or more ^{*)}
– Deformation of the deck (EN 1990 Annex 2 A2.4.4.2.3)	1	1 or 2 ^{*)}	1 or 2 or 3 or more ^{*)}
– Horizontal deflection of the deck (EN 1990 Annex 2 A2.4.4.2.4)	1	1 or 2 ^{*)}	1 or 2 or 3 or more ^{*)}
– Combined response of structure and track to variable actions including limits to vertical and longitudinal displacement of the end of a deck (6.5.4)	1	1 or 2 ^{*)}	1 or 2 ^{*)}
– Vertical acceleration of the deck (EN1991-2 6.4.6 and EN 1990 Annex 2 A2.4.4.2.1)	1	1	1
SLS Checks:			
– Passenger comfort criteria (EN 1990 Annex 2 A2.4.4.3)	1	1	1
ULS Checks			
– Avoidance of unrestrained uplift at bearings	1	1 or 2 ^{*)}	1 or 2 or 3 or more ^{*)}

^{*)} whichever is critical (see multi-component actions)

Table 25 - Number of tracks to be loaded for checking limits of deflection and vibration

- v in m/s (V in km/h) is the maximum line speed;
- g is the acceleration due to the gravity and
- r is the radius of curvature in m, should be suitably taken as mean value in case of a curve of varying radii.

Centrifugal forces should be combined with the vertical traffic load. The centrifugal force shall not be multiplied by the dynamic factor Φ_2 or Φ_3 .

The factor f allows for the reduced mass of higher speed trains. For the associated vertical loading two cases need to be considered: reduced vertical loading due to lower mass and full vertical loading, in fact for short loaded lengths very high speed light vehicles dictate the magnitude of centrifugal forces.

For Load Model 71 (and where required Load Model SW/0) the reduction factor f is given by:

$$f = \left[1 - \frac{V - 120}{1000} \left(\frac{814}{V} + 1,75 \right) \left(1 - \sqrt{\frac{2,88}{L_f}} \right) \right], \text{ where} \quad (59)$$

L_f is the influence length in m of the loaded part of curved track on the bridge, which is most unfavourable for the design of the structural element under consideration and V is the maximum speed.

$f=1$ for either $V \leq 120$ km/h or $L_f \leq 2,88$ m

$f < 1$ for 120 km/h $< V \leq 300$ km/h and $L_f > 2,88$ m

$f(V) = f(300)$ for $V > 300$ km/h.

For Load Model 71 (and where required Load Model SW/0) the cases considered in table 26 shall be considered.

Value of α	Maximum Line Speed at Site [km/h]	Centrifugal force based on : ^a				Associated vertical traffic action based on: ^a
		V [km/h]	α	f		
$\alpha < 1$	> 120	V	1^c	f	$1^c \times f \times$ (LM71"+SW/0) for case 6.5.1(7)b	$\Phi \times \alpha \times 1 \times$ (LM71"+SW/0)
		120	α	1	$\alpha \times 1 \times$ (LM71"+SW/0) for case 6.5.1(7)a	$\Phi \times \alpha \times 1 \times$ (LM71"+SW/0)
		0	-	-	-	
	≤ 120	V	α	1	$\alpha \times 1 \times$ (LM71"+SW/0)	
		0	-	-	-	
$\alpha = 1$	> 120	V	1	f	$1 \times f \times$ (LM71"+SW/0) for case 6.5.1(7)b	$\Phi \times 1 \times 1 \times$ (LM71"+SW/0)
		120	1	1	$1 \times 1 \times$ (LM71"+SW/0) for case 6.5.1(7)a	$\Phi \times 1 \times 1 \times$ (LM71"+SW/0)
		0	-	-	-	
	≤ 120	V	1	1	$1 \times 1 \times$ (LM71"+SW/0)	
		0	-	-	-	
$\alpha > 1$	$> 120^b$	V	1	f	$1 \times f \times$ (LM71"+SW/0) for case 6.5.1(7)b	$\Phi \times 1 \times 1 \times$ (LM71"+SW/0)
		120	α	1	$\alpha \times 1 \times$ (LM71"+SW/0) for case 6.5.1(7)a	$\Phi \times \alpha \times 1 \times$ (LM71"+SW/0)
		0	-	-	-	
	≤ 120	V	α	1	$\alpha \times 1 \times$ (LM71"+SW/0)	
		0	-	-	-	

^a $0,5 \times$ (LM71"+SW/0) instead of (LM71"+SW/0) where vertical traffic actions favourable.
^b Valid for heavy freight traffic limited to a maximum speed of 120 km/h.
^c $\alpha = 1$ to avoid double counting the reduction in mass of train with f .
^d See 6.5.1(3) regarding vertical effects of centrifugal loading. Vertical load effect of centrifugal loading less any reduction due to cant should be enhanced by the relevant dynamic factor. When determining the vertical effect of centrifugal force, factor f to be included as shown above.

Table 26 – Load cases for centrifugal forces

8.5.2 Nosing force

The nosing force, to be always combined with a vertical traffic load, shall be taken as a concentrated force acting horizontally, at the top of the rails, perpendicularly to the centre-line of track. It shall be applied on both straight track and curved track. For rail traffic with a maximum

axle load of 250 kN, the characteristic value should be taken as $Q_{sk}=100$ kN and it should not be multiplied neither by the factor α , when $\alpha < 1$, nor for the dynamic magnification factor.

When a value of $\alpha > 1$ is specified for traffic with greater axle loads, α should also be applied to the nosing force.

8.5.3 Actions due to traction and braking

Traction and braking forces acting at the top of the rails in the longitudinal direction of the track are commonly considered as uniformly distributed over the corresponding influence length $L_{a,b}$ for traction and braking effects for the structural element considered.

The characteristic values of traction and braking forces, which are applicable to all types of track construction, e.g. continuous welded rails or jointed rails, with or without expansion devices, should be taken as follows:

Traction force : $Q_{lak} = 33$ [kN/m] $L_{a,b}$ [m] ≤ 1000 [kN]
for Load Models 71, SW/0, SW/2, “unloaded train” and HSLM

Braking force : $Q_{lbk} = 20$ [kN/m] $L_{a,b}$ [m] ≤ 6000 [kN]
for Load Models 71, SW/0 and Load Model HSLM
 $Q_{lbk} = 35$ [kN/m] $L_{a,b}$ [m]
for Load Model SW/2
 $Q_{lbk} = 2,5$ [kN/m] $L_{a,b}$ [m]
for Load Model “unloaded train”

In special cases, like for lines carrying special traffic (restricted to high speed passenger traffic for example) the traction and braking forces may be taken as equal to 25% of the sum of the axle-loads (Real Train) acting on the influence length of the action effect of the structural element considered, with a maximum value of 1000 kN for Q_{lak} and 6000 kN for Q_{lbk} .

8.6 Multicomponent actions

8.6.1 Characteristic values of multicomponent actions

The simultaneity of the above mentioned loadings may be taken into account by considering the groups of loads defined in table 27. Each of these groups of loads, which are mutually exclusive, should be considered as defining a single variable characteristic action for combination with non-traffic loads. Each group of loads should be applied as a single variable action.

8.6.2 Other representative values of the multicomponent actions

For frequent values of multicomponent actions the same rule given above is applicable by applying the factors given in table 27 for each group, to the frequent values of the relevant actions considered in each group.

Quasi-permanent traffic actions shall be taken as zero.

number of tracks on structure			Groups of loads		Vertical forces			Horizontal forces			Comment			
			Reference EN 1991-2	number of tracks loaded	Load Group ⁽¹⁾	Loaded track	6.3.2/6.3.3	6.3.3	6.3.4	6.5.3		6.5.1	6.5.2	
1	2	3	1	gr 11	T ₁	1			1 ⁽¹⁾	0,5 ⁽¹⁾	0,5 ⁽¹⁾	Max. vertical 1 with max. longitudinal		
			1	gr 12	T ₁	1				0,5 ⁽¹⁾	1 ⁽¹⁾	1 ⁽¹⁾	Max. vertical 2 with max. transverse	
			1	gr 13	T ₁	1 ⁽¹⁾				1	0,5 ⁽¹⁾	0,5 ⁽¹⁾	Max. longitudinal	
			1	gr 14	T ₁	1 ⁽¹⁾				0,5 ⁽¹⁾	1	1	Max. lateral	
			1	gr 15	T ₁				1		1 ⁽¹⁾	1 ⁽¹⁾	Lateral stability with "unloaded train"	
			1	gr 16	T ₁		1			1 ⁽¹⁾	0,5 ⁽¹⁾	0,5 ⁽¹⁾	SW/2 with max. longitudinal	
			1	gr 17	T ₁		1			0,5 ⁽¹⁾	1 ⁽¹⁾	1 ⁽¹⁾	SW/2 with max. transverse	
			2	gr 21	T ₁ T ₂	1 1				1 ⁽¹⁾ 1 ⁽¹⁾	0,5 ⁽¹⁾ 0,5 ⁽¹⁾	0,5 ⁽¹⁾ 0,5 ⁽¹⁾	0,5 ⁽¹⁾ 0,5 ⁽¹⁾	Max. vertical 1 with max. longitudinal
			2	gr 22	T ₁ T ₂	1 1				0,5 ⁽¹⁾ 0,5 ⁽¹⁾	1 ⁽¹⁾ 1 ⁽¹⁾	1 ⁽¹⁾ 1 ⁽¹⁾	1 ⁽¹⁾ 1 ⁽¹⁾	Max. vertical 2 with max. transverse
			2	gr 23	T ₁ T ₂	1 ⁽¹⁾ 1 ⁽¹⁾				1 1	0,5 ⁽¹⁾ 0,5 ⁽¹⁾	0,5 ⁽¹⁾ 0,5 ⁽¹⁾	0,5 ⁽¹⁾ 0,5 ⁽¹⁾	Max. longitudinal
			2	gr 24	T ₁ T ₂	1 ⁽¹⁾ 1 ⁽¹⁾				0,5 ⁽¹⁾ 0,5 ⁽¹⁾	1 ⁽¹⁾ 1	1 ⁽¹⁾ 1	1 ⁽¹⁾ 1	Max. lateral
			2	gr 26	T ₁ T ₂	1 1		1		1 ⁽¹⁾ 1 ⁽¹⁾	0,5 ⁽¹⁾ 0,5 ⁽¹⁾	0,5 ⁽¹⁾ 0,5 ⁽¹⁾	0,5 ⁽¹⁾ 0,5 ⁽¹⁾	SW/2 with max. longitudinal
			2	gr 27	T ₁ T ₂	1 1		1		0,5 ⁽¹⁾ 0,5 ⁽¹⁾	1 ⁽¹⁾ 1 ⁽¹⁾	1 ⁽¹⁾ 1 ⁽¹⁾	1 ⁽¹⁾ 1 ⁽¹⁾	SW/2 with max. transverse
			≥3	gr 31	T ₁	0,75					0,75 ⁽¹⁾	0,75 ⁽¹⁾	0,75 ⁽¹⁾	Additional load case

- (1) All relevant factors (α , ϕ , f , ...) shall be taken into account.
- (2) SW/0 shall only be taken into account for continuous beam structures.
- (3) SW/2 needs to be taken into account only if it is stipulated for the line.
- (4) Factor may be reduced to 0,5 if favourable effect, it cannot be zero.
- (5) In favourable cases these non-dominant values shall be taken equal to zero.
- (6) HSLM and Real Trains where required in accordance with 6.4.4 and 6.4.6.1.1.
- (7) If a dynamic analysis is required in accordance with 6.4.4 see also 6.4.6.5(3) and 6.4.6.1.2.
- (8) See also Table A2.3 of EN 1990

- Dominant component action as appropriate
- to be considered in designing a structure supporting one track (Load Groups 11-17)
- to be considered in designing a structure supporting two tracks (Load Groups 11-27 except 15). Each of the two tracks shall be considered as either T₁ (Track one) or T₂ (Track 2)
- to be considered in designing a structure supporting three or more tracks; (Load Groups 11 to 31 except 15. Any one track shall be taken as T₁, any other track as T₂ with all other tracks unloaded. In addition the Load Group 31 has to be considered as an additional load case where all unfavourable lengths of track T₁ are loaded.

Table 27. Assessment of groups of traffic loads (characteristic values of multicomponent actions)

8.7 Fatigue load models

A fatigue damage assessment shall be carried out for all structural elements, which are subjected to fluctuations of stress. For normal traffic based on characteristic values of Load Model 71, including the dynamic factor Φ , the fatigue assessment should be carried out on the basis of three different traffic mixes, *usual traffic*, *traffic with 250 kN-axles* or *light traffic mix* depending on whether the structure carries mixed traffic, predominantly heavy freight traffic or lightweight passenger traffic, as specified below.

Each of the traffic mixes is based on an annual traffic tonnage of 25×10^6 tonnes passing over the bridge on each track.

For structures carrying multiple tracks, the fatigue loading shall be applied to a maximum of two tracks in the most unfavourable positions.

The fatigue damage should be assessed over a structural life of 100 years.

Alternatively, the fatigue assessment may be carried out on the basis of a special traffic mix and structural life.

When dynamic effects are likely to be excessive, additional requirements for the fatigue

assessment of bridges should be considered.

8.7.1 Assumption for fatigue actions

Static dynamic factors Φ_2 and Φ_3 which are applied to the static Load Model 71 ($\alpha = 1,0$) and SW/0 and SW/2, represent the extreme loading case to be taken into account for detailing bridge members. These factors would be unduly onerous if they were applied to the Real Trains used for making an assessment of fatigue damage, so to take account of the average effect over the assumed 100 years life of the structure, the dynamic enhancement for each Real Train is reduced, for Maximum Permitted Vehicle Speeds up to 200km/h, to

$$1 + \frac{1}{2}(\varphi' + \frac{1}{2}\varphi''), \text{ where} \quad (60)$$

$$\varphi' = \frac{K}{1 - K + K^4} \text{ and } \varphi'' = 0,56e^{-\frac{L^2}{100}} \quad (61)$$

being v the Maximum Permitted Vehicle Speed in m/s, L the determinant length L_Φ in m and

$$K = \frac{v}{160} \text{ for } L \leq 20 \text{ m and } K = \frac{v}{47,16L^{0,408}} \text{ for } L > 20 \text{ m.}$$

8.7.2 The λ -factor design method

The fatigue assessment is in general a stress range verification, carried out according to EN 1992, EN 1993 and EN 1994 on the basis of the λ -method.

As an example, for steel bridges the safety verification shall be carried out by ensuring that the following condition is satisfied:

$$\gamma_{FF} \lambda \Phi_2 \Delta\sigma_{71} \leq \frac{\Delta\sigma_c}{\gamma_{MF}} \quad (62)$$

where γ_{FF} is the partial safety factor for fatigue loading, usually taken equal to 1.00, λ is the damage equivalent factor for fatigue which takes account of the service traffic on the bridge and the span of the member, Φ_2 is the dynamic factor, $\Delta\sigma_{71}$ is the stress range due to the Load Model 71 (and where required SW/0) excluding α being placed in the most unfavourable position for the element under consideration, $\Delta\sigma_c$ is the reference value of the fatigue strength and γ_{MF} is the partial safety factor for fatigue strength in the design codes

8.7.3 Train types for fatigue

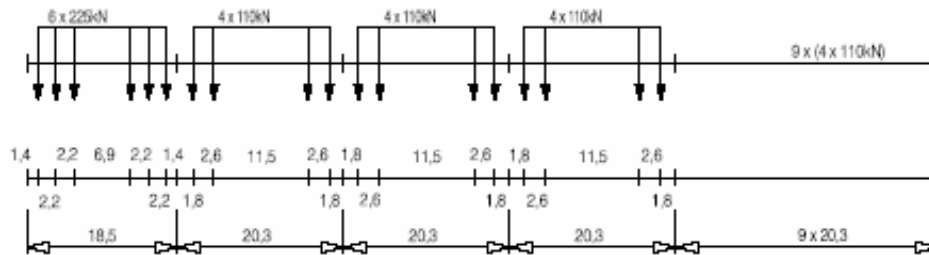
As stated above, fatigue assessment should be carried out on the basis of three traffic mixes, depending on the expected railway traffic.

Details of the service trains and traffic mixes are given below.

(1) Standard and light traffic mixes

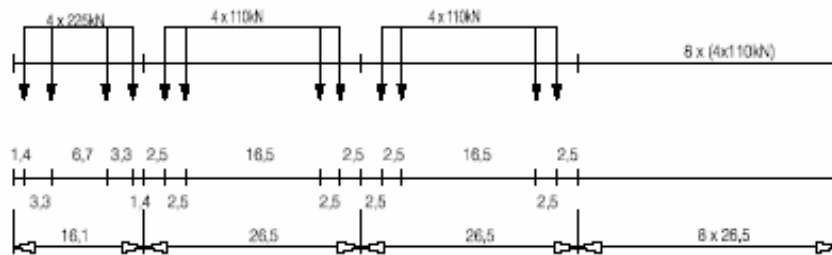
Type 1 Locomotive-hauled passenger train

$$\Sigma Q = 6630\text{kN} \quad V = 200\text{km/h} \quad L = 262,10\text{m} \quad q = 25,3\text{kN/m'}$$



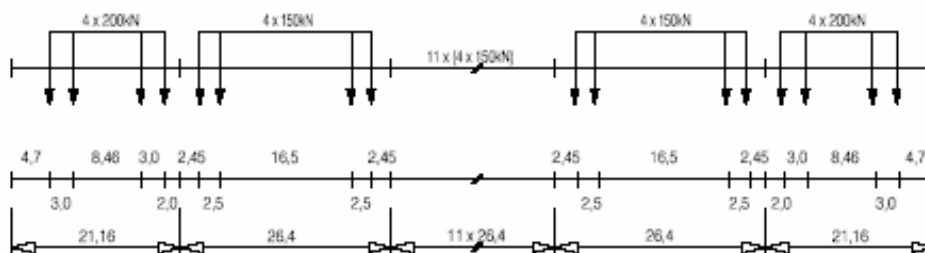
Type 2 Locomotive-hauled passenger train

$$\Sigma Q = 5300\text{kN} \quad V = 160\text{km/h} \quad L = 281,10\text{m} \quad q = 18,9\text{kN/m'}$$



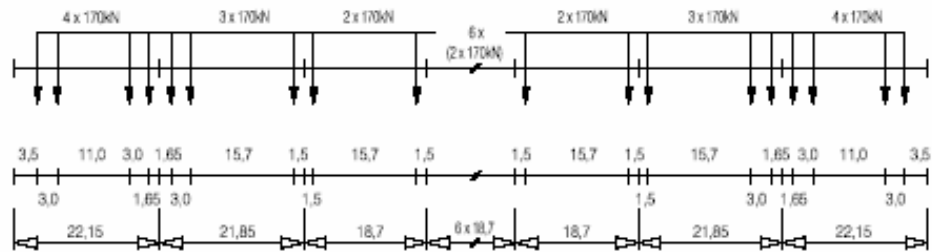
Type 3 High speed passenger train

$$\Sigma Q = 9400\text{kN} \quad V = 250\text{km/h} \quad L = 385,52\text{m} \quad q = 24,4\text{kN/m'}$$



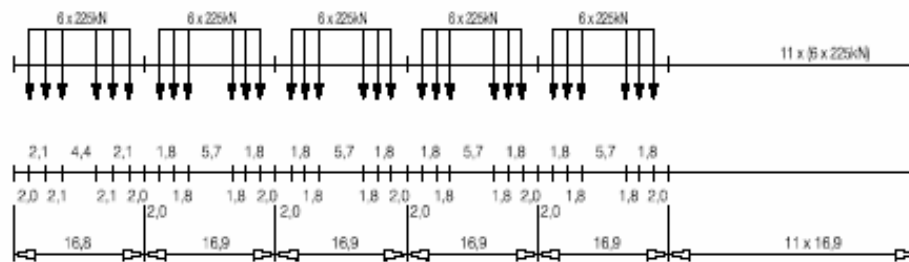
Type 4 High speed passenger train

$\Sigma Q = 5100\text{kN}$ $V = 250\text{km/h}$ $L = 237,60\text{m}$ $q = 21,5\text{kN/m}$



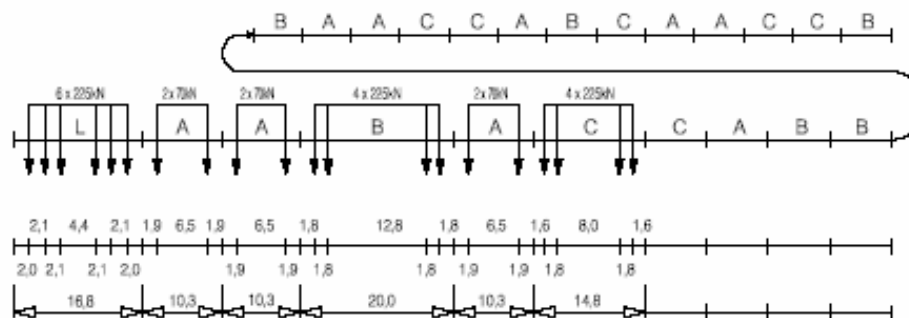
Type 5 Locomotive-hauled freight train

$\Sigma Q = 21600\text{kN}$ $V = 80\text{km/h}$ $L = 270,30\text{m}$ $q = 80,0\text{kN/m}$



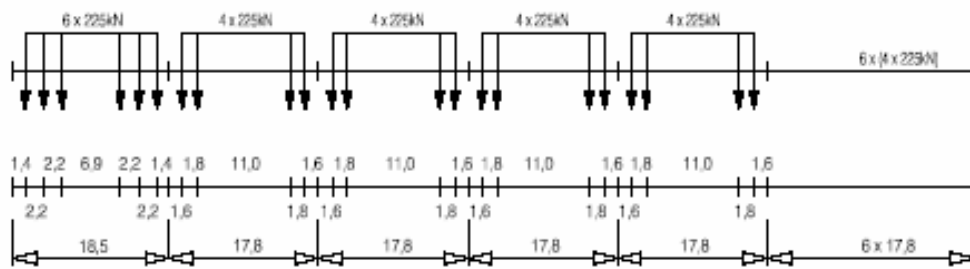
Type 6 Locomotive-hauled freight train

$\Sigma Q = 14310\text{kN}$ $V = 100\text{km/h}$ $L = 333,10\text{m}$ $q = 43,0\text{kN/m}$



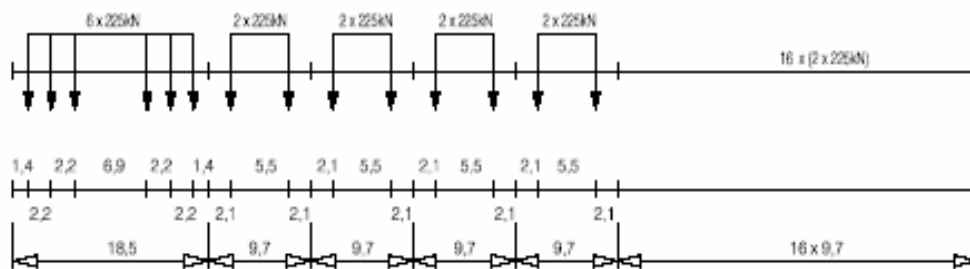
Type 7 Locomotive-hauled freight train

$\Sigma Q = 10350\text{kN}$ $V = 120\text{km/h}$ $L = 196,50\text{m}$ $q = 52,7\text{kN/m}$



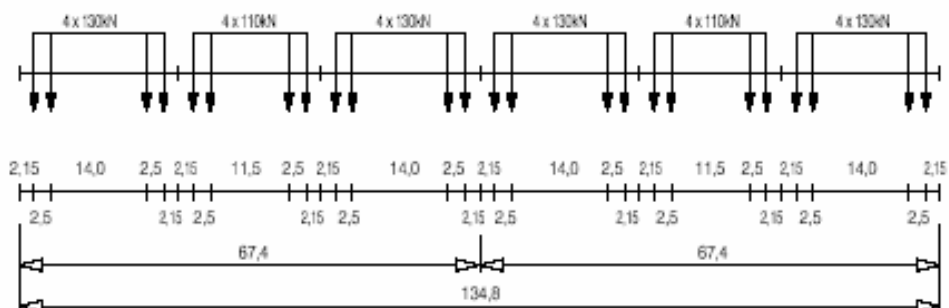
Type 8 Locomotive-hauled freight train

$\Sigma Q = 10350\text{kN}$ $V = 100\text{km/h}$ $L = 212,50\text{m}$ $q = 48,7\text{kN/m}$



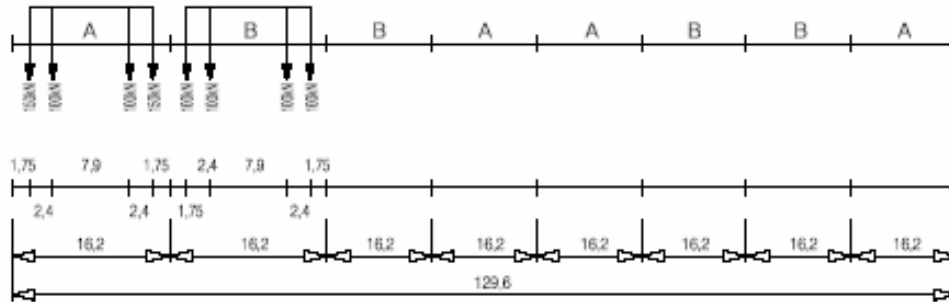
Type 9 Suburban multiple unit train

$\Sigma Q = 2960\text{kN}$ $V = 120\text{km/h}$ $L = 134,80\text{m}$ $q = 22,0\text{kN/m}$



Type 10 Underground

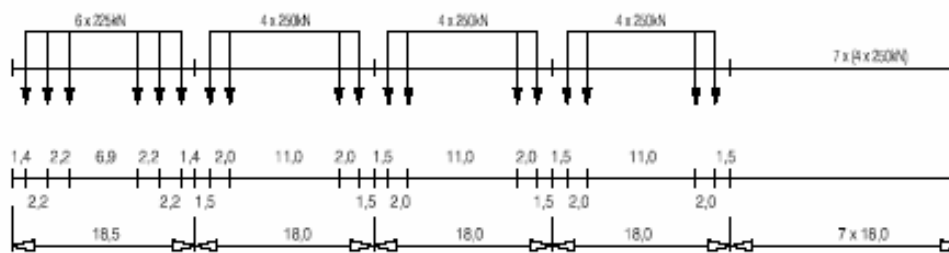
$$\Sigma Q = 3600\text{kN} \quad V = 120\text{km/h} \quad L = 129,60\text{m} \quad q = 27,8\text{kN/m'}$$



(2) Heavy traffic with 250 kN - axles

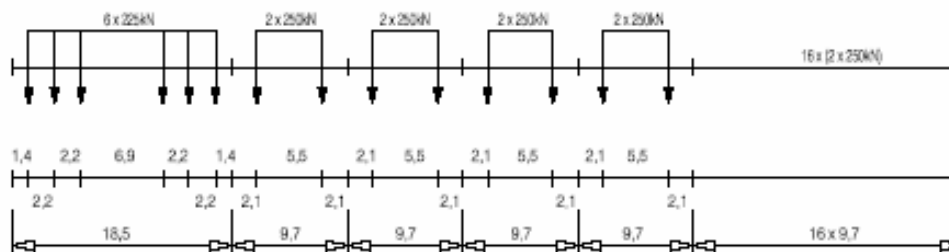
Type 11 Locomotive-hauled freight train

$$\Sigma Q = 11350\text{kN} \quad V = 120\text{km/h} \quad L = 198,50\text{m} \quad q = 57,2\text{kN/m'}$$



Type 12 Locomotive-hauled freight train

$$\Sigma Q = 11350\text{kN} \quad V = 100\text{km/h} \quad L = 212,50\text{m} \quad q = 53,4\text{kN/m'}$$



(3) Traffic mix:

Table D.1 - Standard traffic mix with axles $\leq 22,5$ t (225 kN)

Train type	Number of trains/day	Mass of train [t]	Traffic volume [10^6 t/year]
1	12	663	2,90
2	12	530	2,32
3	5	940	1,72
4	5	510	0,93
5	7	2160	5,52
6	12	1431	6,27
7	8	1035	3,02
8	6	1035	2,27
	67		24,95

Table D.2 - Heavy traffic mix with 25t (250 kN) axles

Train type	Number of trains/day	Mass of train [t]	Traffic volume [10^6 t/year]
5	6	2160	4,73
6	13	1431	6,79
11	16	1135	6,63
12	16	1135	6,63
	51		24,78

Table D.3 - Light traffic mix with axles $\leq 22,5$ t (225 kN)

Train type	Number of trains/day	Mass of train [t]	Traffic volume [10^6 t/year]
1	10	663	2,4
2	5	530	1,0
5	2	2160	1,4
9	190	296	20,5
	207		25,3

REFERENCES

- Bruls, A. & al. 1996.a. ENV1991 Part 3: The main model of traffic loads on road bridges. Background studies. *IABSE Colloquium on Basis of Design and Actions on Structures. Background and Application of Eurocode 1*. Delft.
- Bruls, A. & al. 1996.b. ENV1991 Part 3: Traffic loads on bridges. Calibration of road load models for road bridges. *IABSE Colloquium on Basis of Design and Actions on Structures. Background and Application of Eurocode 1*. Delft.
- Caramelli S & Croce P. 2000. Messina bridge: testing assisted deck fatigue design. *Proceedings of the IIW International Conference on Welded construction: achievement and perspective for the new millennium*. Florence.

- Croce, P. & al. 1991. I modelli di carico dei ponti stradali dell'Eurocodice 1 – Azioni nelle strutture. *Atti del XIII Congresso CTA*. Abano Terme.
- Croce, P. & al. 1997. Stochastic modelling of traffic loads for multilane effect evaluation. *Advances in Safety & Reliability. Proceedings of ESREL '97*. Lisbon.
- Croce, P. & Salvatore, W. 1998. Stochastic modelling of traffic loads for long span bridges. *IABSE Symposium Long Span and High-Rise Structures*. Kobe.
- Croce, P. & Salvatore, W. 2001. Stochastic model for multi-lane traffic effects on bridges. *Journal of Bridge Engineering*, ASCE, 3
- Croce, P. & Sanpaolesi, L. 1991. Analisi del traffico stradale per le verifiche dei ponti. *Atti delle Giornate AICAP 1991*. Spoleto.
- Croce, P. 1996. Vehicle interactions and fatigue assessment of bridges. *IABSE Colloquium on Basis of Design and Actions on Structures. Background and Application of Eurocode 1*. Delft.
- Croce, P. 2002. Background to fatigue load models for Eurocode 1: Part 2 Traffic Loads. *Progress in Structural Engineering and Materials*, n. 3.
- EN1991-2. *Eurocode 1: Basis of Design and Actions on Structures. Part 2: Traffic Loads on Bridges*.
- Sedlacek, G. & al. 1991. *Eurocode 1 - Part 12. Traffic loads on road bridges. Definition of dynamic impact factors. Report of subgroup 5*.
- Tschemmernegg, F. & al. 1989. Verbreiterung und Sanierung von Stahlbrücken. *Stahlbau* n. 9.

CHAPTER 2: ACCIDENTAL ACTIONS ON BRIDGES

Ton Vrouwenvelder

Delft University of Technology/TNO Bouw, The Netherlands

Summary

The accidental actions covered by Part 1.7 of EN 1991 are discussed and guidance for their application in design calculations is given. A short summary is presented of the main clauses in the code for collisions due to trucks. After the presentation of the clauses an example is given in order to get some idea of the design procedure and the design consequences.

1 INTRODUCTION

1.1 General

General principles for classification of actions on structures, including accidental actions and their modeling in verification of structural reliability, are introduced in EN 1990 Basis of Design. In particular EN 1990 defines the various design values and combination rules to be used in the design calculations. A detailed description of individual actions is then given in various parts of Eurocode 1, EN 1991. Part 1.7 of EN 1991 covers accidental actions and gives rules and values for the following topics:

- impact loads due to road traffic
- impact loads due to train traffic
- impact loads due to ships

It should be kept in mind that the loads in the main text are rather conventional. More advanced models are presented in annex. C. Apart from design values and other detailed information for the loads mentioned above, the document EN 1991, Part 1-7 also gives guidelines how to handle accidental loads in general. In many cases structural measures alone cannot be considered as very efficient.

1.2 Background Documents

Part 1.7 of EN 1991 is partly based on the requirements put forward in the Eurocode on traffic loads (ENV 1991-3) and some ISO-documents. For the more theoretical parts use has been made of prenormalisation work performed in IABSE [1] and CIB [2]. Specific backgrounds information can be found in [3], [4] and [5].

2. BASIS OF APPLICATIONS

In order to reduce the risk involved in accidental type of load one might, as basic strategies, consider probability reducing as well as consequence reducing measures, including contingency plans in the event of an accident. Risk reducing measures should be given high priority in design for accidental actions, and also be taken into account in design. Design with respect to accidental actions may therefore pursue one or more as appropriate of the following strategies, which may be mixed in the same design:

1. *preventing the action* occurring or reducing the probability and/or magnitude of the action to a reasonable level. (The limited effect of this strategy must be recognised; it depends on factors which, over the life span of the structure, are normally outside the control of the structural design process)
2. *protecting the structure* against the action (e.g. by traffic bollards)
3. *designing* in such a way that neither the whole structure nor an important part thereof will collapse if a local failure (single element failure) should occur
4. *designing key elements*, on which the structure would be particularly reliant, with special care, and in relevant cases for appropriate accidental actions
5. *applying prescriptive design/detailing rules* which provide in normal circumstances an acceptably robust structure (e. g. tri-orthogonal tying for resistance to explosions, or minimum level of ductility of structural elements subject to impact). For prescriptive rules Part 1.7 refers to the relevant ENV 1992 to ENV 1999.

The design philosophy necessitates that accidental actions are treated in a special manner with respect to load factors and load combinations. Partial load factors to be applied in analysis according to strategy no. 3 are defined in Eurocode, Basis of Design, to be 1.0 for all loads (permanent, variable and accidental) with the following qualification in: "Combinations for accidental design situations either involve an explicit accidental action A (e.g. fire or impact) or refer to a situation after an accidental event ($A = 0$)". After an accidental event the structure will normally not have the required strength in persistent and transient design situations and will have to be strengthened for a possible continued application. In temporary phases there may be reasons for a relaxation of the requirements e.g. by allowing wind or wave loads for shorter return periods to be applied in the analysis after an accidental event. As an example Norwegian rules for offshore structures [6] are referred to.

3. LOADS DUE TO VEHICLE COLLISIONS

In the case of hard impact, design values for the horizontal actions due to impact on vertical structural elements (e.g. columns, walls) in the vicinity of various types of internal or external roads may be obtained from Table 3.1. The forces F_{dx} and F_{dy} denote respectively the forces in the driving direction and perpendicular to it. There is no need to consider them simultaneously. The collision forces are supposed to act at 1,25 m above the level of the driving surface (0,5 m for cars). The force application area may be taken as 0,25 m (height) by 1,50 m (width) or the member width, whichever is the smallest.

In addition to the values in this Table the code specifies more advanced models for nonlinear and dynamic analysis in an informative annex.

Type of road	Type of vehicle	Force F_{dx} [kN]	Force F_{dy} [kN]
Motorway	Truck	1000	500
Country road	Truck	750	375
Urban area	Truck	500	250
Courtyards	Passengers cars only	50	25
Courtyards	Trucks	150	75

Table 3.1: Horizontal static equivalent design forces due to impact on supporting substructures of structures over roadways

4 DESIGN EXAMPLES OF A BRIDGE PIER FOR COLLISION

Consider the reinforced concrete bridge pier of figure 4.1. The cross sectional dimensions are $b = 0.50$ m and $h = 1.00$ m. The column height $h = 5$ m and it is assumed to be hinged to both the bridge deck as to the foundation structure. The reinforcement ratio is 0.01 for all four groups of bars as indicated in figure 4.1, right hand side. Let the steel yield stress be equal to 300 MPa and the concrete strength 50 MPa. The column will be checked for impact by a truck under motorway conditions.

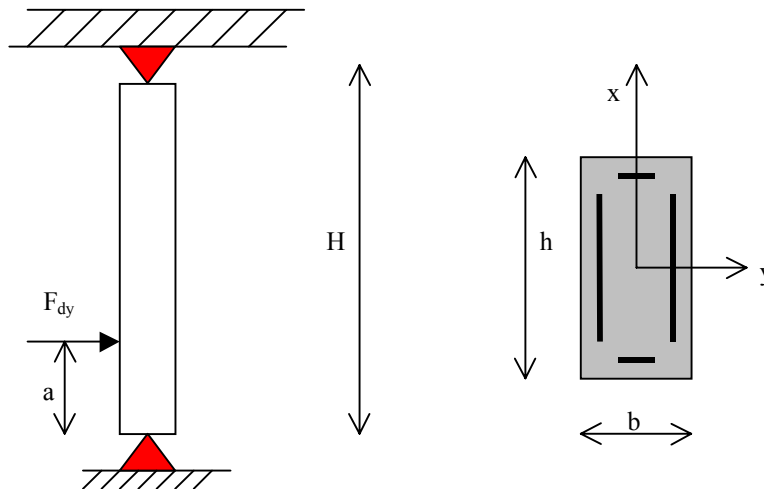


Figure 4.1 Bridge pier under impact loading

According to the code, the forces F_{dx} and F_{dy} should be taken as 1000 kN and 500 kN respectively and act at a height of $a = 1.25$ m. The design value of the bending moments and shear forces resulting from the static force in longitudinal direction can be calculated as follows:

$$M_{dx} = \frac{a(H - a)}{H} F_{dx} = \frac{1.25(5.00 - 1.25)}{5.00} 1000 = 940 \text{ kNm}$$

$$Q_{dx} = \frac{H-a}{H} F_{dx} = \frac{5.00-1.25}{5.00} 1000 = 750 \text{ kN}$$

Similar for the direction perpendicular to the diving direction:

$$M_{dy} = \frac{a(H-a)}{H} F_{dy} = \frac{1.25(5.00-1.25)}{5.00} 500 = 470 \text{ kNm}$$

$$Q_{xy} = \frac{H-a}{H} F_{dy} = \frac{5.00-1.25}{5.00} 500 = 375 \text{ kN}$$

Other loads are not relevant in this case. The self weight of the bridge deck and traffic loads on the bridge only lead to a normal force in the column. Normally this will increase the load bearing capacity of the column. So we may confine ourselves to the accidental load only.

Using a simplified model, the bending moment capacity can conservatively be estimated from:

$$M_{Rdx} = 0.8 \omega h^2 b f_y = 0.8 \cdot 0.01 \cdot 1.00^2 \cdot 0.50 \cdot 300\,000 = 1200 \text{ kNm}$$

$$M_{Rdy} = 0.8 \omega h b^2 f_y = 0.8 \cdot 0.01 \cdot 1.00 \cdot 0.50^2 \cdot 300\,000 = 600 \text{ kNm}$$

As no partial factor on the resistance need to be used in the case of accidental loading, the bending moment capacities can be considered as sufficient. The shear capacity of the column, based on the concrete tensile part (say $f_{ctk} = 1200 \text{ kN/m}^2$) only is approximately equal to:

$$Q_{Rd} = 0.3 b h f_{ctk} = 0.3 \cdot 1.00 \cdot 0.50 \cdot 1200 = 360 \text{ kN}.$$

This is almost sufficient for the loading in y-direction, but not for the x-direction. An additional shear force reinforcement is necessary.

5. DISCUSSION ON Annex C

The informative Annex C of EN 1001 Part 1-7 gives the designer information on background information for dynamic calculations in the case of impact loading. A correct impact assessment requires a nonlinear dynamic analysis of a model that comprises both the structure as the impacting body. The annex demonstrates the principles of such an analysis using simple empirical models. It should be noted that more advanced models might be appropriate in special cases or background studies.

In the assumption that the structure is rigid and immovable and the colliding object deforms linearly during the impact phase and remains rigid during unloading, the maximum resulting dynamic interaction force is given by:

$$F = v_r \sqrt{k m} \quad (5.1)$$

where v_r is the object velocity at impact; k is the equivalent elastic stiffness of the object (i.e. the ratio between force F and total deformation); m is the mass of the colliding object. The stiffness, of course, is some kind of an averaged equivalent value, incorporating all kind of geometrical and physical nonlinearities in the mechanics of the collision process. Some reasonable estimates for these quantities are:

		mean value	standard deviation
m	mass	20 ton	12 ton
v	velocity	80 km/hr	10 km/hr
k	equivalent stiffness	300 kN/m	

As we are considering a loading situation conditional upon the accidental event of collision, there is no need to use extreme fractiles of these distributions. In many cases one chooses to use the mean plus one standard deviation. In this case this leads to $m = 32$ ton and $v = 90$ km/hr = 25 m/s and from there we find:

$$F = 25 \sqrt{(300 * 32)} = 2400 \text{ kN}$$

Compared to the $F = 1000$ kN in table 3.1 this is a large number. However, we should keep in mind that the load in table 3.1 is intended as a static value, where the force (5.1) acts only over a short period of time. The shape of the force due to impact can usually be assumed as a rectangular pulse and the duration of the pulse is then given by:

$$\Delta t = \sqrt{m / k} \tag{5.2}$$

In the given example the duration would be 0.3 s. Another point is that the vehicle usually loses speed between the point where it leaves the track and the point where it hits the structure. For a given deceleration a the velocity after a distance s from the critical point is given by:

$$v_r = \sqrt{(v_0^2 - 2 a s)} \tag{5.3}$$

Using $a = 4$ m/s² and we arrive at a distance $s = 80$ m. This means that the force will be zero if the distance between the centre line of the track and the structural element is about 20 m. Here it has been assumed that the angle $\varphi = 15^\circ$. For intermediate distances one may use the expression:

$$F = F_0 \sqrt{1 - d / d_b} \quad (\text{for } d < d_b) \tag{5.4}$$

Note that the value of d_b may be adjusted because of the terrain characteristics.

The force (5.1) is the force at the impact surface between the structure and the impacting vehicle. Inside the structure this load will lead to dynamic effects. As long as the structure behaves elastically there may be some dynamic amplification (one may think of 40 percent). However, due to elastic-plastic effects stresses may be reduced

6 REFERENCES

- [1] Ole Damgaard Larsen
Structural Engineering Documents
“Ship Collision with bridges”, The interaction between Vessel traffic and Bridge structures
- [2] Actions on structures impact
CIB Report, Publication 167, CIB, Rotterdam 1992
- [3] T. Vrouwenvelder
Stochastic modelling of extreme action events in structural engineering
Probabilistic Engineering Mechanics 15 (2000) 109-117
- [4] Project Team ENV 1991-2-7
Background document to ENV 1991-2-7
Accidental actions due to impact and explosions
- [5] Ton Vrouwenvelder
Design for ship impact according to Eurocode 1, Part 2.7
Ship collision analysis, Gluwer and Olson, 1998 Balkema, ISBN 9054109629
- [6] Norwegian Petroleum Directorate:
Regulations concerning load bearing structures in the petroleum activities 1992

CHAPTER 3: EN 1991-2, TRAFFIC LOADS ON BRIDGES: EXAMPLE OF CONCRETE BRIDGE DESIGN

Stefano Colombini

Department of Structural Engineering, University of Pisa

SUMMARY

This chapter examines an example of a bridge with a prestressed reinforced concrete (r.c.) structure. It focuses on analysis of the loads permissible on the structure according to the provisions of regulations EN 1991-2, “Actions on structures - Traffic loads on bridges”, with the ultimate aim of clarifying the manners in which the loads are applied and how each of them contributes to determining the stresses on the structure. However, thorough verification of the bridge and its component parts is beyond our present scope.

1 DESCRIPTION OF THE BRIDGE

The bridge covers an effective span of 45.0 m, with a static scheme of simple abutment (figure 1). The structure is made up of four equal longitudinal beams, distanced 2.70 m one from the other, which sustain a 0.30 m-thick concrete slab (figure 2). The beams are connected by transverse stiffening beams, arranged in correspondence to the two supports and the sections at one third the bridge’s length.

The roadway is 7.50 m wide, and is flanked on each side by walkways 2.0 m in width, separated from the central road by safety barriers. The bridge is located in an urban area (hence the need for such ample walkways). The distance between the bridge’s intrados and an underlying roadway is 6.0 m.

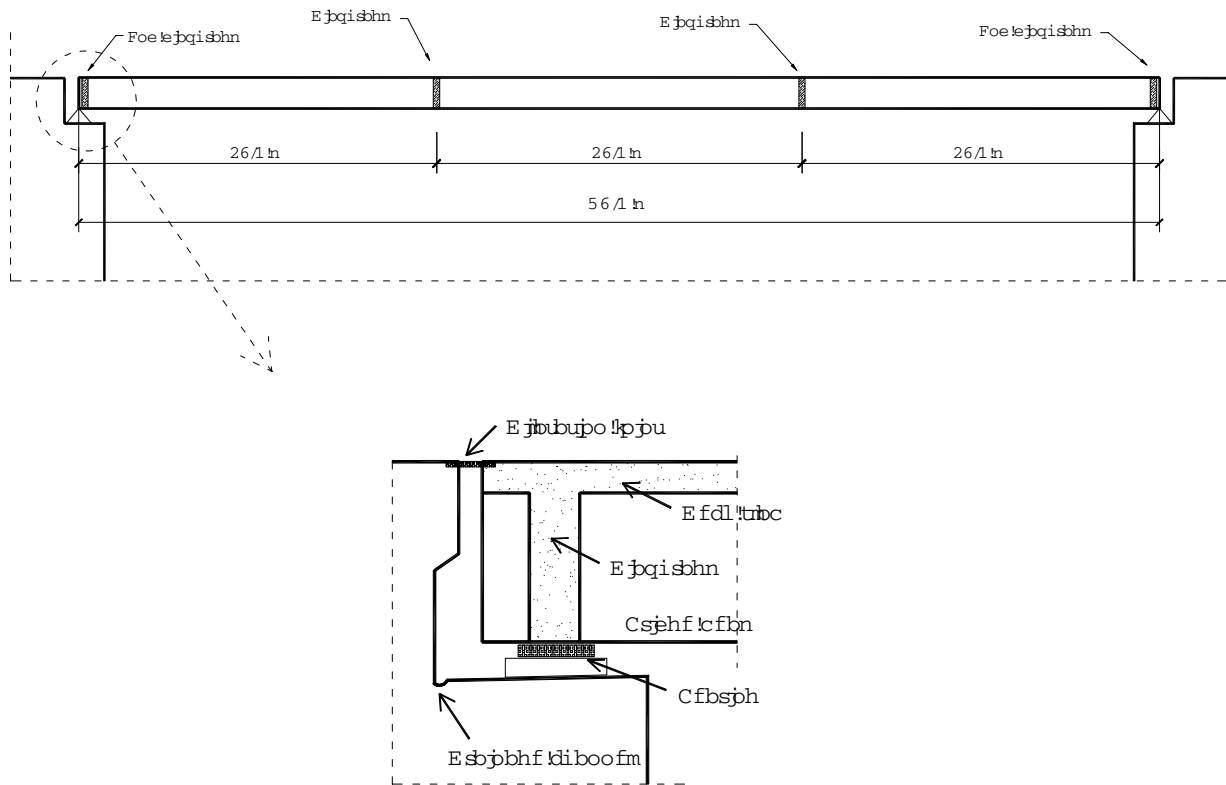


Figure 1: bridge static scheme and support detail.

1.1 Geometric characteristics of a single longitudinal beam

Each of the four longitudinal beams has a straight section $A_b = 1.476 \text{ m}^2$ and an inertial moment with respect to the barycentre of $J = 1.43738 \text{ m}^4$; the beam's barycentre is 1.581 m from the its upper extremity.

2 DEFINITION OF LOADS

2.1 Structural self weights

Assuming a specific weight, $\gamma = 25.0 \text{ kN/m}^3$ for the reinforced concrete, the weight of each beam is:

$$g_b = A_b \gamma = 36.9 \text{ kN/m}$$

The thickness of the concrete slab is 300 mm; therefore, its weight is:

$$g_s = 7.5 \text{ kN/m}^2.$$

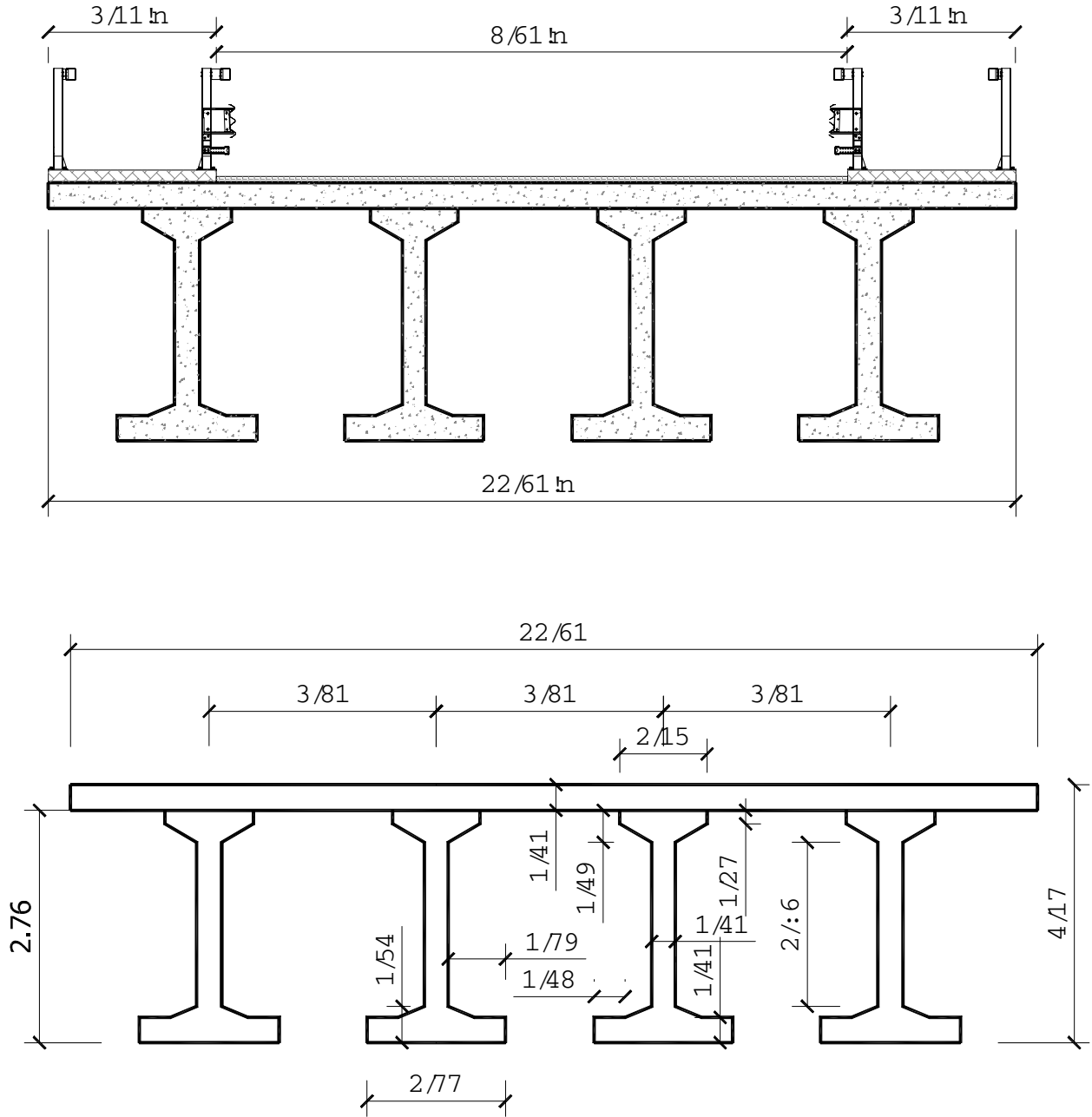


Figure 2: characteristics of the bridge transverse section (unit: m).

2.2 Dead loads

The dead loads that the structure has to sustain include the flooring, walkways, safety barriers and guardrails. These can be quantified as a distributed load $g_{add} = 2.5 \text{ kN/m}^2$ (for instance, a specific weight of 23 kN/m^3 has been taken for the asphalt, as per the guidelines set forth in EN 1991 “Actions on structures. Part 1-1: densities, self weight and imposed loads”), to which we must add 60 daN/m for each of the guardrails.

2.3 Traffic loads

According to EN 1991-2 “Actions on structures. Part 2: general actions - Traffic loads on bridges”, the first operation to be performed consists of determining the width w of the roadway and the number of notional lanes. The value of the roadway width w depends, first of all, on whether the walkways are isolated from vehicular traffic or not. In the case presented at the onset, there are guardrails that make the walkways accessible to pedestrians alone. Therefore, the width w is delimited by the net distance between the aforesaid guardrails, which is $w = 7.50 \text{ m}$.

As $w > 6.0 \text{ m}$ and, according to regulations, the number of conventional lanes (each of width $w_1 = 3.0 \text{ m}$) is afforded by the relation:

$$n_1 = \text{Int} \left[\frac{w}{3} \right] = \text{Int} \left[\frac{7.50 \cdot \text{m}}{3} \right] = 2$$

The width of the residual area is the complement, which is:

$$w_r = w - n_1 \cdot 3.0 \text{ m} = 7.50 \text{ m} - 2 \cdot 3.0 \text{ m} = 1.50 \text{ m}$$

The situation is thus that illustrated in figure 3.

Eurocode 1, part 2, calls for four separate calculation models. Herein, only Load Models, LM1 and LM4 (pedestrian traffic) are relevant, as Load Model 2 concerns local verifications, and Model 3 the transit of special vehicles over the bridge (which must be considered only when expressly required).

Each lane must provide for a pair of tandem axles (each axle represents a load of αQ Q_k , accompanied by a uniform distribution $\alpha_0 q_k$).

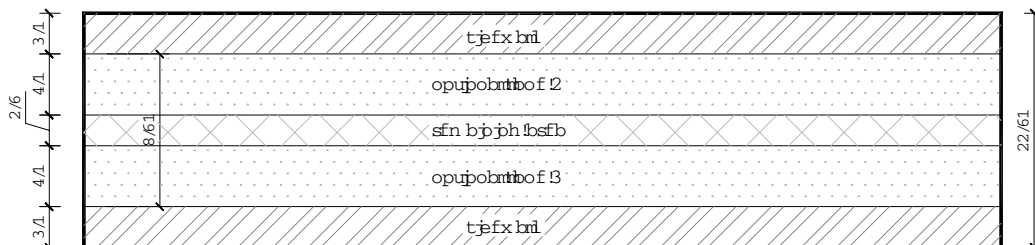


Figure 3: definition of the conventional lanes (unit: m).

Regarding Q_k and q_k , Table 1 shows their values, calculated including the dynamic amplification coefficient.

Conventional lane	Q_k [kN]	q_k [kN/m ²]
Lane 1	300	9.0
Lane 2	200	2.5
Residual area	0	2.5

Table 1: loads distributed and concentrated on the conventional lanes of the bridge.

Eurocode 1 allows for assuming a value of $\alpha Q = 0.8$ for the first conventional lane (1.0 for the others). We however believe it more appropriate to assume $\alpha Q = 1.0$, as per indications set forth in the same regulation, according to which this value leads to results very near the actual traffic effects on medium-span bridges (from 25 m to 50 m, which includes the bridge in question). Thus, we have:

Lane 1: $Q_{1k} = 1.0 \times 300 \text{ kN} = 300 \text{ kN}$
 Lane 2: $Q_{1k} = 1.0 \times 200 \text{ kN} = 200 \text{ kN}$

Coefficient α_q is also assumed to be equal to unity.

Regarding the pedestrian traffic load, the regulation prescribes a nominal value of 5.00 kN/m², but recommends 2.5 kN/m² as the combination value. The LM1 and LM4 loads must be distributed in the least favourable way (both transversally and longitudinally) for a determined effect, bearing in mind however that a single lane cannot hold more than one pair of tandem axles, and that the axle, if present, must be considered in full, that is to say, with all four wheels.

By way of example, figure 4 shows a possible arrangement of the loads on the roadway.

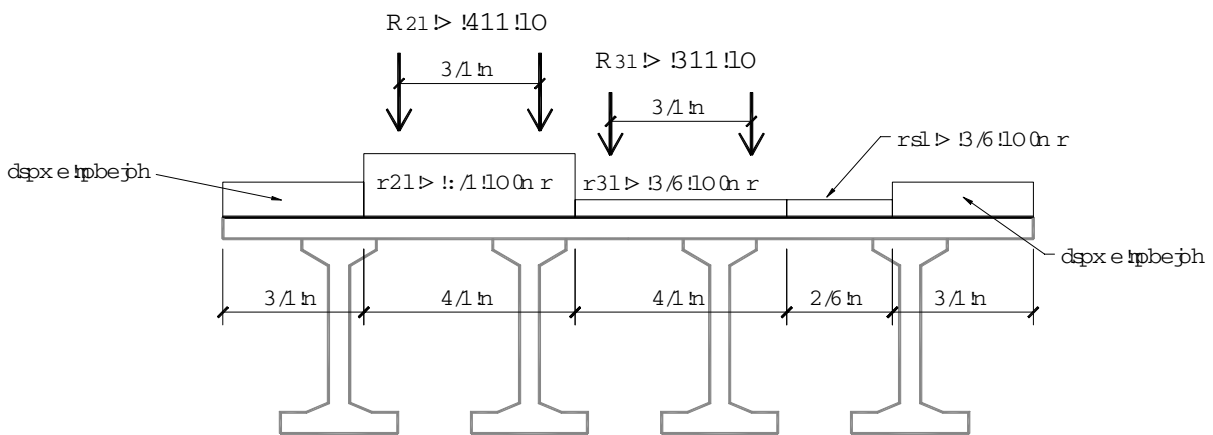


Figure 4: possible distribution of traffic loads.

2.4 Wind action

The effects of the wind translate into a vertical action, orthogonal to the roadway plane, and a horizontal one. This latter can be further decomposed into two distinct components, one parallel and one orthogonal to the bridge's longitudinal axis.

Firstly, we determine the equivalent pressure exerted by the wind, which is calculated through the expression:

$$q_p(z_e) = c_e(z_e) \cdot \frac{\rho}{2} \cdot v_b^2$$

in which ρ represents the air density, which can reasonably be assumed to be equal to 1.25 kg/m³.

v_b indicates the calculation wind velocity, while C_e is the so-called exposure coefficient, calculated at reference altitude z_e and defined as:

$$C_e(z_e) = C_r^2(z_e) \cdot C_0^2(z_e) \cdot [1 + 7 \cdot I_v(z_e)]$$

which includes the roughness coefficient, C_r , the topography factor, C_0 and the turbulence intensity I_v . The topography factor, introduced in order to account for any significant local variations in the site's topography, can usually be assumed to equal unity. For I_v and C_r , instead, the followings relations hold:

$$I_v(z_e) = \begin{cases} \frac{k_I}{C_0(z_e) \cdot \ln\left(\frac{z}{z_0}\right)} & \text{se } z_{\min} < z \\ I_v(z_{\min}) & \text{se } z_{\min} \geq z \end{cases}$$

$$C_r(z_e) = \begin{cases} k_r(z_e) \cdot \ln\left(\frac{z}{z_0}\right) & \text{se } z_{\min} < z \\ C_r(z_{\min}) & \text{se } z_{\min} \geq z \end{cases}$$

where k_I is a turbulence factor, usually set equal to one, while k_r , z_0 and z_{\min} are quantities defined as a function of the site's exposure category. As stated, the bridge in question is located in an urban setting, and the site therefore falls into category 4, for which we have the values: $z_0 = 1.0$ m, $z_{\min} = 10.0$ m, and $k_r = 0.262$. The reference height z_e represents the altitude at which the midline of the bridge's profile lies (figure 5). Considering, as previously stated, that the intrados of the structure is 6.0 m from ground level, we have $z_e = 6.0$ m + 1.53 m = 7.53 m.

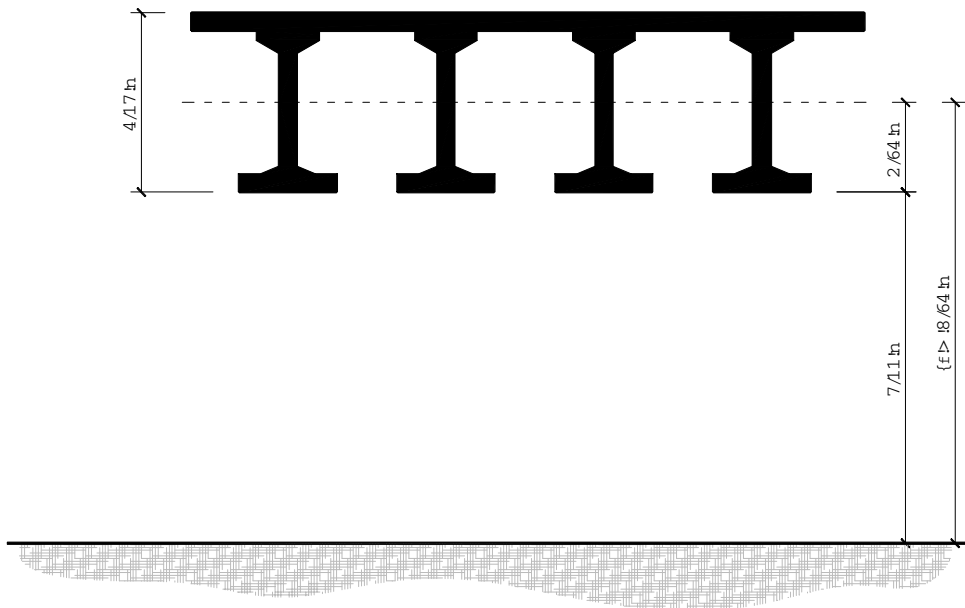


Figure 5: definition of the equivalent height for calculation of wind actions

As $Z_e < z_{\min}$, it holds that:

$$I_v(z_e) = I_v(z_{\min}) = \frac{1}{10 \cdot \ln\left(\frac{10 \cdot \text{m}}{10 \cdot \text{m}}\right)} = 0.434$$

$$C_r(z_e) = C_r(z_{\min}) = 0.262 \cdot \ln\left(\frac{10 \cdot \text{m}}{10 \cdot \text{m}}\right) = 0.603$$

and therefore:

$$C_e(z_e) = C_e(z_{\min}) = 0.603^2 \cdot 1.0^2 \cdot [1 + 7 \cdot 0.434] = 1.468$$

Wind velocity is function of geographic site, here we assume $v_b = 27$ m/s, and we calculate the equivalent pressure as:

$$q_p(z_e) = 1.468 \cdot \frac{1.25}{2} \cdot 27.0^2 = 668.86 \text{ N/m}^2 \cong 0.67 \text{ kN/m}^2$$

Indicating 'x' as the horizontal direction orthogonal to the bridge's axis, following the notation adopted in Eurocode 1, part 1-4 (EN 1991-1-4: "Actions on structures. General actions. Wind actions"), the force acting on the bridge is given by:

$$F_{w,x} = q_p(z_e) \cdot C_{f,x} \cdot A_{ref,x}$$

The coefficient, $C_{f,x}$, is a function of the ratio between the deck's height and its width, and also depends on the presence of any safety barriers, guardrails and their types. As the bridge design calls for open safety barriers, 1.20 m in height, for a total deck height, $b = 3.06 \text{ m} + 1.20 \text{ m} = 4.26 \text{ m}$, the ratio d/b turns out to be $d/b = (11.50 \text{ m}) / (4.26 \text{ m}) = 3.76$, with a corresponding $C_{f,x}$ value of 1.69. The reference area on which the wind acts in direction 'x' must also take into account the presence of safety barriers and guardrails. According to Eurocode 1, if both a parapet and a guardrail are present on each side, we can add a default value of 1.20 m to the deck height, thereby calculating the area $A_{ref,x}$ via the formula:

$$A_{ref,x} = (3.06 \text{ m} + 1.20 \text{ m}) \cdot L = 4.26 \text{ m} \cdot L$$

where L is the length of the bridge.

The transverse horizontal action of the wind can then be expressed as a uniformly distributed load per unit length:

$$F_{w,x} = q_p(z_e) \cdot C_{f,x} \cdot A_{ref,x} = 0.67 \text{ kN/m}^2 \cdot 1.69 \cdot 4.26 \text{ m} = 4.82 \text{ kN/m}$$

Regarding instead the vertical action, lacking more precise data from wind tunnel tests, the coefficient $C_{f,z}$ to utilise is:

$$C_{f,z} = \pm 0.9$$

whose sign '+' or '-' is to be chosen so as to assume the least favourable situation. The reference area in this case is the horizontal projection of the bridge deck.

$$F_{w,z} = q_p(z_e) \cdot C_{f,z} \cdot A_{ref,z} = 0.67 \text{ kN/m}^2 \cdot (\pm 0.9) \cdot 1150 \text{ m} = \pm 6.93 \text{ kN/m}$$

Such action must be applied with eccentricity, e , with respect to the longitudinal axis of the bridge:

$$e = \frac{d}{4} = \frac{1150 \text{ m}}{4} = 2.875 \text{ m}$$

Finally, in the 'y' direction (bridge longitudinal axis), the action to be considered is 25% of that for the direction orthogonal to the axis.

2.5 Thermal actions

As we are dealing with an isostatic structure, that is, beams simply resting on supports, it is a well-known fact that uniform thermal variations and linear thermal variations, as any

given state of coactions, do not cause stresses. Stress can be caused by non linear thermal variations, but we don't analyse this situation. The effects of thermal variation, therefore, involve only displacements and deformations of the structure, and are have thus been omitted in this example (they will instead be addressed in examples regarding bridges with hyperstatic schemes).

3 CALCULATING THE STRESSES

3.1 Distribution of the loads on the main beams.

Firstly, we shall determine the load share borne by each of the four longitudinal beams. To this end, we apply the classic Courbon distribution, which is based on the assumption that the transverse element is very stiff in comparison to the longitudinal beams.

When n beams are all equal and arranged at a constant distance, b_0 one from the other, a generic load P , applied at a distance e from the deck's barycentric axis, induces a reaction, R_i , in the i^{th} beam:

$$R_i = Q \cdot \left(\frac{1}{n} + \frac{d_i \cdot e}{\sum_{i=1}^n d_i^2} \right)$$

in which d_i is the distance between the beam and the barycentric axis. It is evident that the most heavily stressed beam is the external one because, all other quantities being equal, the distance d_i in the numerator of the right-hand fraction is at a maximum. For the outer beam then, with $n = 4$ and $b_0 = 2.70$ m, we have:

$$R_1 = Q \cdot \left(\frac{1}{n} + \frac{6 \cdot e}{b_0 \cdot (n+1) \cdot n} \right) = Q \cdot \left(\frac{1}{4} + \frac{6 \cdot e}{2.70 \text{ m} \cdot (4+1) \cdot 4} \right)$$

where the load eccentricity e , measured in meters, remains to be inserted.

Now referring to the symbols used in figure 6, for the effects of Load Model 1 (which are maximized by placing the residual area far from the external beam) and the pedestrian load we have the following reactions on the main external beam under exam (figure 6):

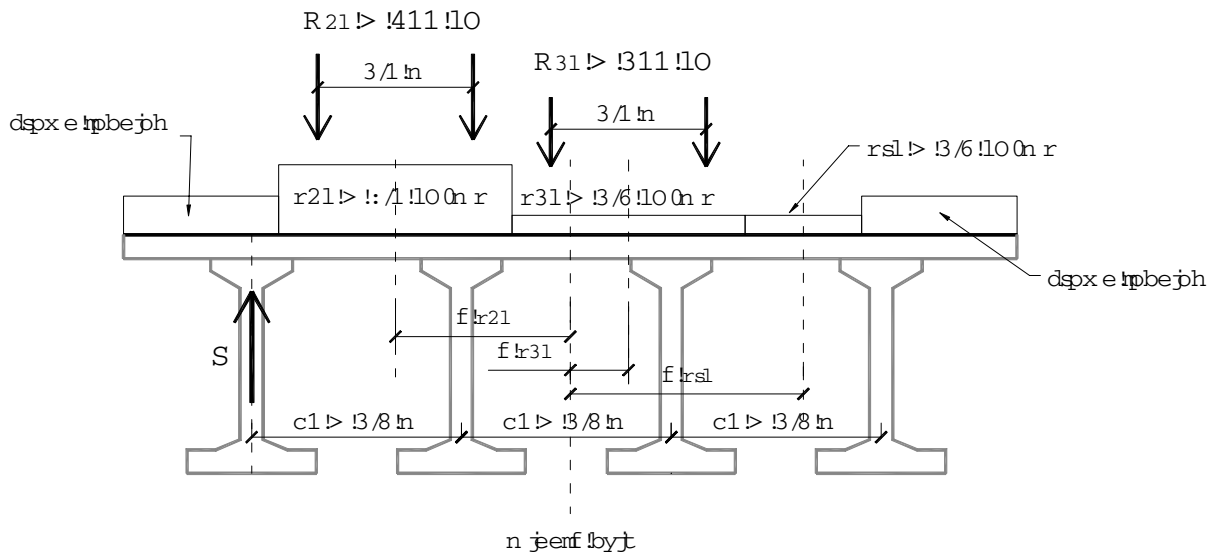


Figure 6: transverse distribution of the loads maximizing the effects (R) on the left edge beam.

Q_1'	$e = 3.25 \text{ m}$
Q_1''	$e = 1.25 \text{ m}$
Q_2'	$e = 0.25 \text{ m}$
Q_2''	$e = -1.75 \text{ m}$

Resultant q_1	$q_1 = 9.0 \text{ kN/m}^2 \times 3.0 \text{ m} = 27.00 \text{ kN/m}$
Resultant q_2	$q_2 = 2.5 \text{ kN/m}^2 \times 3.0 \text{ m} = 7.50 \text{ kN/m}$
Resultant q_r	$q_r = 2.5 \text{ kN/m}^2 \times 1.5 \text{ m} = 3.75 \text{ kN/m}$

Eccentricity of resultant q_1	$e = 2.25 \text{ m}$
Eccentricity of resultant q_2	$e = -0.75 \text{ m}$
Eccentricity of resultant q_r	$e = -3.00 \text{ m}$

Resultant of the pedestrian load (nominal value)	$q_{f-n} = 5.0 \text{ kN/m}^2 \times 2.0 \text{ m} = 10.0 \text{ kN/m}$
Resultant of the pedestrian load (combination value)	$q_{f-c} = 2.5 \text{ kN/m}^2 \times 2.0 \text{ m} = 5.0 \text{ kN/m}$

Pedestrian traffic on the nearest walkway	$e = 4.75 \text{ m}$
Pedestrian traffic on the farthest walkway	$e = -4.75 \text{ m}$

$$R_{Q1'} = Q_1' \left(\frac{1}{4} + \frac{6 \cdot 3.25 \text{ m}}{2.70 \text{ m} \cdot (4+1) \cdot 4} \right) = 0.611 \cdot Q_1' = 0.611 \cdot 150 \text{ kN} = 91.65 \text{ kN}$$

$$R_{Q1''} = Q_1'' \left(\frac{1}{4} + \frac{6 \cdot 1.25 \text{ m}}{2.70 \text{ m} \cdot (4+1) \cdot 4} \right) = 0.389 \cdot Q_1'' = 0.389 \cdot 150 \text{ kN} = 58.35 \text{ kN}$$

$$R_{Q2'} = Q'_2 \cdot \left(\frac{1}{4} + \frac{6 \cdot 0.25 \text{ m}}{2.70 \text{ m} \cdot (4+1) \cdot 4} \right) = 0.278 \cdot Q'_2 = 0.278 \cdot 100 \text{ kN} = 27.80 \text{ kN}$$

$$R_{Q2''} = Q''_2 \cdot \left(\frac{1}{4} + \frac{-6 \cdot 1.75 \text{ m}}{2.70 \text{ m} \cdot (4+1) \cdot 4} \right) = 0.056 \cdot Q''_2 = 0.056 \cdot 100 \text{ kN} = 5.60 \text{ kN}$$

$$R_{q1} = q_1 \cdot \left(\frac{1}{4} + \frac{6 \cdot 2.25 \text{ m}}{2.70 \text{ m} \cdot (4+1) \cdot 4} \right) = 0.500 \cdot q_1 = 0.500 \cdot 27.00 \text{ kN/m} = 13.50 \text{ kN/m}$$

$$R_{q2} = q_2 \cdot \left(\frac{1}{4} + \frac{-6 \cdot 0.75 \text{ m}}{2.70 \text{ m} \cdot (4+1) \cdot 4} \right) = 0.167 \cdot q_2 = 0.167 \cdot 7.50 \text{ kN/m} = 1.25 \text{ kN/m}$$

$$R_{qr} = q_r \cdot \left(\frac{1}{4} + \frac{-6 \cdot 3.00 \text{ m}}{2.70 \text{ m} \cdot (4+1) \cdot 4} \right) = -0.083 \cdot q_r = -0.083 \cdot 3.75 \text{ kN/m} = -0.31 \text{ kN/m}$$

Pedestrian traffic on the walkway nearest the external beam in question:

$$R_{q_{fn}} = q_{fn} \cdot \left(\frac{1}{4} + \frac{6 \cdot 4.75 \text{ m}}{2.70 \text{ m} \cdot (4+1) \cdot 4} \right) = 0.778 \cdot q_{fn} = 0.778 \cdot 10.0 \text{ kN/m} = 7.78 \text{ kN/m}$$

$$R_{q_{fc}} = q_{fc} \cdot \left(\frac{1}{4} + \frac{6 \cdot 4.75 \text{ m}}{2.70 \text{ m} \cdot (4+1) \cdot 4} \right) = 0.778 \cdot q_{fc} = 0.778 \cdot 5.0 \text{ kN/m} = 3.89 \text{ kN/m}$$

Pedestrian traffic on the walkway farthest from the external beam in question:

$$R_{q_{fn}} = q_{fn} \cdot \left(\frac{1}{4} + \frac{-6 \cdot 4.75 \text{ m}}{2.70 \text{ m} \cdot (4+1) \cdot 4} \right) = -0.278 \cdot q_{fn} = -0.278 \cdot 10.0 \text{ kN/m} = -2.78 \text{ kN/m}$$

$$R_{q_{fc}} = q_{fc} \cdot \left(\frac{1}{4} + \frac{-6 \cdot 4.75 \text{ m}}{2.70 \text{ m} \cdot (4+1) \cdot 4} \right) = -0.278 \cdot q_{fc} = -0.278 \cdot 5.0 \text{ kN/m} = -1.39 \text{ kN/m}$$

The effects of the vertical wind action are determined analogously, recalling that it acts with an eccentricity $e = d/4 = 11.50/4 \text{ m} = 2.875 \text{ m}$ with respect to the bridge's longitudinal axis.

$$R_{q_{wz}} = q_{wz} \cdot \left(\frac{1}{4} + \frac{6 \cdot 2.875 \text{ m}}{2.70 \text{ m} \cdot (4+1) \cdot 4} \right) = 0.569 \cdot q_{wz} = 0.569 \cdot 6.93 \text{ kN/m} = 3.94 \text{ kN/m}$$

This same procedure is also applied to evaluate the effects of the guardrails and safety barriers on the external beam.

parapet nearest the external beam in question:

$$e = 5.75 \text{ m}$$

parapet farthest from the external beam in question:

$$e = -5.75 \text{ m}$$

guardrail nearest the external beam in question:

$$e = 3.75 \text{ m}$$

guardrail farthest from the external beam in question: $e = -3.75 \text{ m}$

Hence, we have the following respective effects:

$$R_1 = 60.0 \text{ daN/m} \cdot \left(\frac{1}{4} + \frac{6 \cdot 5.75 \text{ m}}{2.70 \text{ m} \cdot (4 + 1) \cdot 4} \right) = 0.889 \cdot 60.0 \text{ daN/m} = 0.53 \text{ kN/m}$$

$$R_2 = 60.0 \text{ daN/m} \cdot \left(\frac{1}{4} + \frac{-6 \cdot 5.75 \text{ m}}{2.70 \text{ m} \cdot (4 + 1) \cdot 4} \right) = -0.389 \cdot 60.0 \text{ daN/m} = -0.23 \text{ kN/m}$$

$$R_3 = 60.0 \text{ daN/m} \cdot \left(\frac{1}{4} + \frac{6 \cdot 3.75 \text{ m}}{2.70 \text{ m} \cdot (4 + 1) \cdot 4} \right) = 0.667 \cdot 60.0 \text{ daN/m} = 0.40 \text{ kN/m}$$

$$R_4 = 60.0 \text{ daN/m} \cdot \left(\frac{1}{4} + \frac{-6 \cdot 3.75 \text{ m}}{2.70 \text{ m} \cdot (4 + 1) \cdot 4} \right) = -0.167 \cdot 60.0 \text{ daN/m} = -0.10 \text{ kN/m}$$

The self-weights of the concrete slab and pavement are loads whose resultants are centred with respect to the bridge's longitudinal axis, or in other terms, they have nil eccentricity. Accordingly, as all the main beams are identical, each absorbs a portion equal to 25%. Therefore, the following dead loads bear down on the external beam:

concrete slab: $g_s = 21.56 \text{ kN/m}$
 flooring: $g_p = 7.19 \text{ kN/m}$

Finally, the beam is subjected to the self-weight:

$$g_b = 36.9 \text{ kN/m}$$

3.2 Calculating the maximum stresses on the main beams.

It should first of all be noted that the distributed load acting on the portion of roadway outside the two notional lanes produces effects of opposite sign on the main beam under exam; the situation holds for the effects due to the pedestrian load present on the walkway farthest from said beam, as well as those from the respective guardrail and parapet. Now in order to impose the least favourable situation with respect to the beam in question, these loads ought to be omitted. By the same reasoning as before, we consider only the in-pressure action of the vertical component of the wind on the deck and not the in-depression action (whose effects would subtract from, rather than to add to, those of the traffic).

Analysis of the beam simply resting across a span of 45.0 m, subject to uniform load distributions, leads to the values of the maximum bending moment in the midline section, equal to $(qL^2)/8$. For the various contributions we therefore have the following maximum bending moments:

Dead loads (beam, concrete slab, flooring, parapet, guardrail):

$$M_1 = \frac{(36.9 + 21.56 + 7.19 + 0.53 + 0.60) \text{ kN/m} \cdot (45.0 \text{ m})^2}{8} = 168531 \text{ kN m}$$

Wind:

$$M_w = \frac{3.94 \text{ kN/m} \cdot (45.0 \text{ m})^2}{8} = 997.3 \text{ kN m}$$

Distributed overload on conventional lane 1:

$$M_{q1} = \frac{13.5 \text{ kN/m} \cdot (45.0 \text{ m})^2}{8} = 34172 \text{ kN m}$$

Distributed Overload on conventional lane 2:

$$M_{q2} = \frac{1.25 \text{ kN/m} \cdot (45.0 \text{ m})^2}{8} = 3164 \text{ kN m}$$

Pedestrian traffic (nominal value):

$$M_{fn} = \frac{7.78 \text{ kN/m} \cdot (45.0 \text{ m})^2}{8} = 19693 \text{ kN m}$$

Pedestrian traffic (combination value):

$$M_{fc} = \frac{3.89 \text{ kN/m} \cdot (45.0 \text{ m})^2}{8} = 984.6 \text{ kN m}$$

Some cautions are in order regarding the concentrated loads corresponding to the axis of Load Model 1. According to the theorem of Asimont, the maximum value of the bending moment occurs in the section on which one of the two tandem axles is applied at a distance from the beam midline equal to half that between the aforesaid axle and the resultant of the moving load train. Using the notation in figure 7, the verifiable absolute maximum moment on the beam occurs in section 's' and is:

$$M_{\max} = M(s) = \frac{R}{4} \cdot \left(L - 2 \cdot c + \frac{c^2}{L} \right)$$

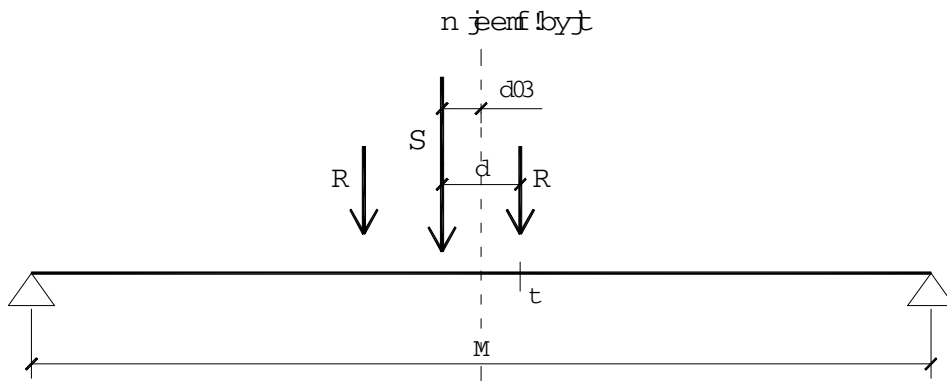


Figure 7: Distribution of a moving train of loads that yields the maximum absolute bending moment in the simply supported beam (theorem of Asimont).

Instead, by applying the resultant of the pair of tandem axles in correspondence to the midline, we obtain a constant bending moment between the concentrated loads, which equals:

$$M_{\max} = \frac{R}{4} \cdot (L - 2 \cdot c)$$

In the case in question, $c = 1.20/2 \text{ m} = 0.60 \text{ m}$ and $L = 45.0 \text{ m}$. For these two values of the bridge span and interaxis of the concentrated loads, the ratio between the two aforesaid bending moments is:

$$\frac{M_{\max}}{M'_{\max}} = \frac{5476}{5475} = 1.00018265 \cdot 10^{-4} (\cong 0.018\%)$$

Given the percentage difference between these two values, it is absolutely acceptable practice to apply the concentrated loads with the resultant in correspondence to the beam's midline.

Loads distributed on Conventional Lane 1:

$$R = 2 \cdot (91.65 \text{ kN} + 58.35 \text{ kN}) = 300.0 \text{ kN}$$

$$M_{\max} = \frac{300.0 \text{ kN}}{4} \cdot (45.0 \text{ m} - 2 \cdot 0.60 \text{ m}) = 3285.0 \text{ kN m}$$

Loads distributed on Conventional Lane 2:

$$R = 2 \cdot (27.80 \text{ kN} + 5.60 \text{ kN}) = 66.80 \text{ kN}$$

$$M_{\max} = \frac{66.8 \text{ kN}}{4} \cdot (45.0 \text{ m} - 2 \cdot 0.60 \text{ m}) = 7315 \text{ kN m}$$

The following Table summarises the calculated stresses.

Load type	Bending moment at the midline [kN m]
Self weight and dead loads	16853.1
Wind (vertical component as pressure)	997.3
Overloads distributed on lane 1	3417.2
Overloads distributed on lane 2	316.2
Pedestrian traffic (nominal value)	1969.3
Pedestrian traffic (combination value)	984.6
Two axles on lane 1	3285.0
Two axles on lane 2	731.5

Table 2: values of the maximum bending moment in the external longitudinal beam for the various load conditions.

Combining the stresses is performed via the well-known symbolic rule:

$$\sum_{j \geq 1} \gamma_{G,j} \cdot G_{k,j} + \gamma_P \cdot P + \gamma_{Q,1} \cdot Q_{1,k} + \sum_{i > 1} \gamma_{Q,i} \cdot \psi_{0,i} \cdot Q_{k,i}$$

where the symbols have their usual meanings. It should be recalled that the following values have been used for the combination coefficients:

$\gamma_G = 1.35$ (or 1.0 when the self-weights have a favourable effect);

$\gamma_Q = 1.5$ (or 0.0 when the self-weights have a favourable effect);

$\psi_0 = 0.6$ for the wind actions.

Thus, considering the bending moment values presented in Table 2, the maximum bending moment in the edge beam is obtained through the following combination, in which the main variable action, Q_{1k} , is represented by the traffic loads (both vehicular and pedestrian):

$$M_{\max} = 1.35 \cdot 168531 \text{ kN m} + 1.5 \cdot (34172 + 3162 + 984.6 + 3285.0 + 7315) \text{ kN m} + 1.5 \cdot 0.6 \cdot 997.3 \text{ kN m} = 367510 \text{ kN m}$$

According to the same criteria it's necessary calculate stress in transverse stiffening beams.

For the purposes of the present example, that aims to illustrate the application modalities of EN 1991-2, Traffic loads on bridges, profit is not thought to develop beyond the design calculations of the bridge.

CHAPTER 4: EN 1991-2, TRAFFIC LOADS ON BRIDGES: EXAMPLE OF A STEEL BRIDGE DESIGN

Stefano Colombini

Department of Structural Engineering, University of Pisa

Summary

This chapter examines an example of a bridge with a steel structure (orthotropic steel deck). It focuses on analysis of the loads permissible on the structure according to the provisions of regulations EN 1991-2, “Actions on structures - Traffic loads on bridges”, with the ultimate aim of clarifying the manners in which the loads are applied and how each of them contributes to determining the stresses on the structure. However, thorough verification of the bridge and its component parts is beyond our present scope.

1 DESCRIPTION OF THE BRIDGE

The bridge covers an effective span of 360 m, with three spans of 120 m each and a static scheme of a continuous beam on four supports (figure 1). The structure is made up of an orthotropic steel deck, with closed stiffeners, sustained by a box girder (figure 2).

Overall, the bridge is 10.50 m wide. The design calls for two lateral walkways, each 1.50 m in width, separated from the roadway by a 10 cm-high pavement. The bridge is to be located in an extra-urban setting. The distance between the bridge intrados and the plane of the underlying ground is 20.0 m.

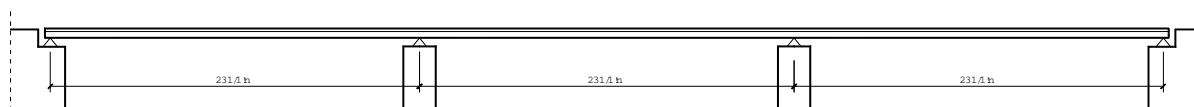


Figure 1: bridge static scheme

1.1 Geometric characteristics of the structure

Each closed rib is 6 mm thick, while the thickness of the deck plate is 14 mm and that of the plates making up the walls of the box girder are 16 mm. Considering the transverse section in its entirety, its barycentre is 1.268 m from the deck extrados, the inertial moment with respect to the barycentric axis is $J = 0.94462 \text{ m}^4$ and the area $A = 0.407 \text{ m}^2$.

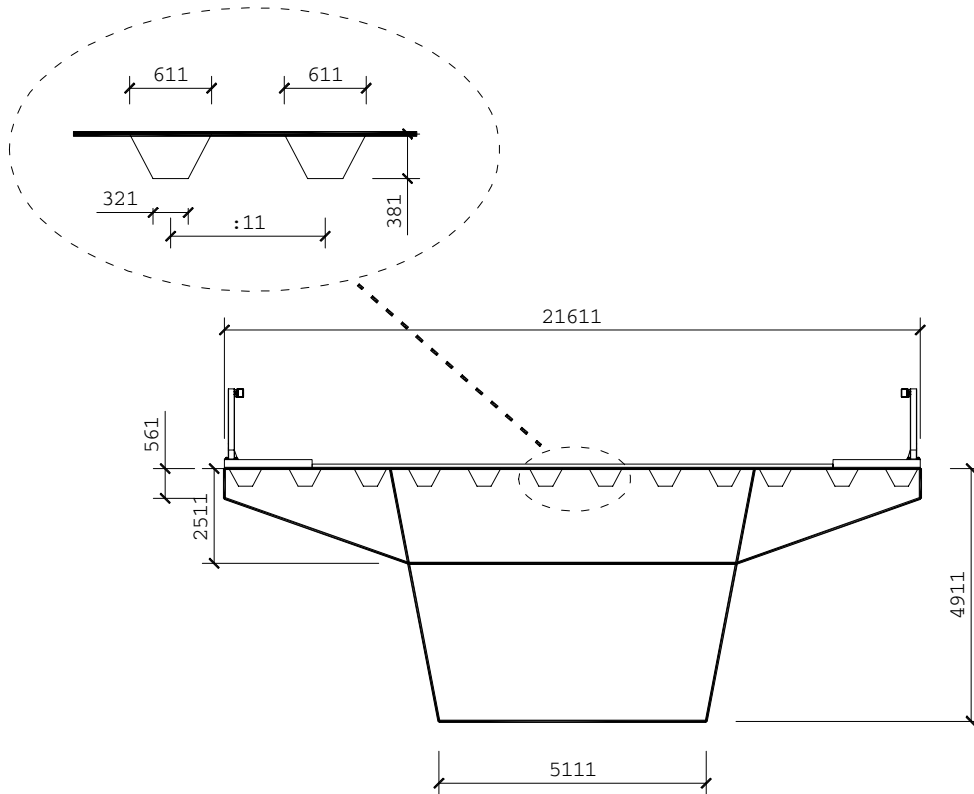


Figure 2: transverse section of the bridge (unit: mm).

2 DEFINITION OF LOADS

2.1 Structural self-weights

Assuming a specific weight, $\gamma = 78.5 \text{ kN/m}^3$, for the steel, the weight of the orthotropic deck (considering the weight of each closed rib to be evenly spread) is:

$$g_b = A_b \gamma = 0.407 \text{ m}^2 \times 78.5 \text{ kN/m}^3 = 31.949 \text{ kN/m}$$

2.2 Dead loads

The dead loads that the structure has to sustain are those due to the roadway surface, the safety barriers and walkways. It is a reasonable approximation to consider these loads “globally”, as distributed per unit surface, by “spreading out” the effects of the safety barriers. Moreover, the asphaltting is considered to be laid directly above the orthotropic deck, without any other interposed surfacing layers. All told, the dead loads have been calculated to be, $g_p = 2.2 \text{ kN/m}^2$, which, given the overall bridge width of 10.5 m, yields a load per unit length of $g_p = g_p \times 10.5 \text{ m} = 23.1 \text{ kN/m}$.

2.3 Traffic loads

According to the guidelines set forth in EN 1991-2 “Actions on structures. Part 2: general actions - Traffic loads on bridges”, we must calculate the roadway width w and number of conventional lanes. The value of the roadway width w depends, first of all, on whether the walkways are isolated from vehicular traffic or not. In the case at hand, the only separation between the pedestrian path and roadway are the 100 mm-high pavements, which, as per the provisions of EN 1991-2, are potentially accessible to the transit of vehicles (because the pavement is not high enough to prevent the wheels of vehicles on the bridge from jumping the curb and ending up on the walkway). For this reason the width w is represented by the net distance between the two outer safety barriers, and therefore $w = 10.50$ m.

As $w > 6.0$ m, regulations stipulate that the number of conventional lanes (each of which has a width, $w_i = 3.0$ m) is given by the relation:

$$n_1 = \text{Int} \left[\frac{w}{3} \right] = \text{Int} \left[\frac{10.50 \cdot \text{m}}{3} \right] = 3$$

A residual area is left, its width given by:

$$w_r = w - n_1 \cdot 3.0 \text{ m} = 10.50 \text{ m} - 3 \cdot 3.0 \text{ m} = 1.50 \text{ m}$$

Thus, the overall situation is that represented in figure 3.

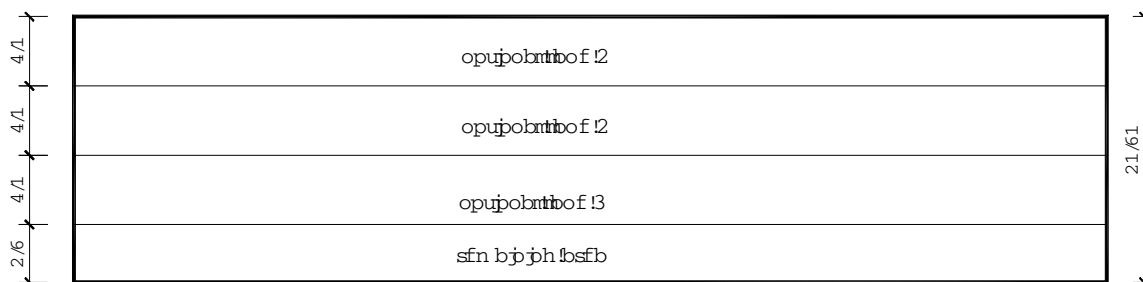


Figure 3: conventional lanes on the bridge roadway (unit: m).

Eurocode 1, part 2, calls for four separate calculation models. For global checks of the structure in question, only Load model LM1 is relevant: pedestrian load (LM4) is not accounted for, as the bridge is in an extra-urban setting, nor does Load model LM3, which interprets the transit of special vehicles on the bridge. In this regard, it should be recalled that Load models LM4 and LM3 need be applied during the calculation stage only when expressly required.

Load model LM1 provides for a pair of tandem axles on each conventional lane (each axle represents a load, $\alpha_Q Q_k$), accompanied by a uniform distribution $\alpha_q q_k$. Table 1 shows the values of these loads for the three conventional lanes and the residual area, calculated including the dynamic amplification coefficient.

Conventional lane	Q_k [kN]	q_k [kN/m ²]
Lane 1	300	9.0
Lane 2	200	2.5
Lane 3	100	2.5
Residual area	0	2.5

Table 1: distributed and concentrated loads on the conventional bridge lanes

Eurocode 1 allows for assuming a value $\alpha = 0.8$ for the first conventional lane (1.0 for the others), for both the concentrated loads and the uniform load. We thus have:

$$\begin{aligned}
 \text{Lane 1: } Q_{1k} &= 0.8 \times 300 \text{ kN} = 240 \text{ kN} & q_{1k} &= 0.8 \times 9.0 \text{ kN/m} = 7.2 \text{ kN/m} \\
 \text{Lane 2: } Q_{2k} &= 1.0 \times 200 \text{ kN} = 200 \text{ kN} & q_{2k} &= 1.0 \times 2.5 \text{ kN/m} = 2.5 \text{ kN/m} \\
 \text{Lane 3: } Q_{3k} &= 1.0 \times 200 \text{ kN} = 200 \text{ kN} & q_{3k} &= 1.0 \times 2.5 \text{ kN/m} = 2.5 \text{ kN/m}
 \end{aligned}$$

When seeking a determined effect on the bridge, the loads for model LM1 must obviously be arranged in the least favourable fashion (both transversally and longitudinally), recalling however that a single lane cannot hold more than one pair of tandem axles, and that the tandem, if present, needs to be considered in full, that is, with all four wheels.

By way of example, one possible arrangement of the roadway loads is represented in figure 4.

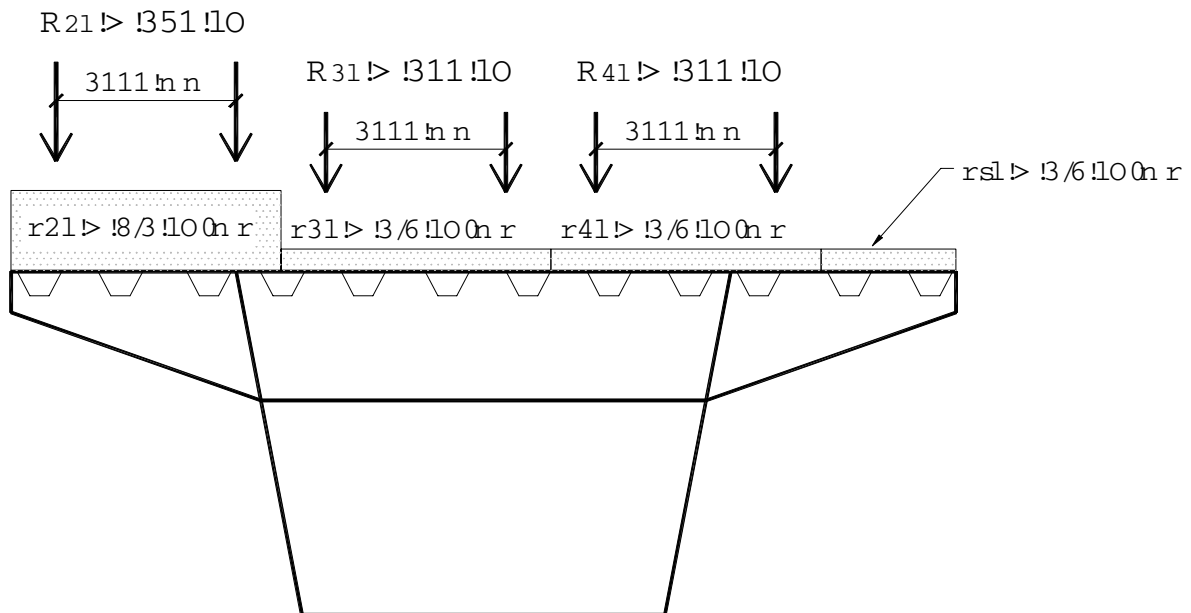


Figure 4: example arrangement of the conventional lanes and residual area with relative traffic loads as per LM1.

2.4 Wind action

The effects of the wind translate into a vertical action, orthogonal to the roadway plane, and a horizontal one with two components, one parallel and one orthogonal to the bridge's longitudinal axis.

It is firstly necessary to determine the equivalent pressure exerted by the wind, which is calculated through the well-known expression:

$$q_p(z_e) = c_e(z_e) \cdot \frac{\rho}{2} \cdot v_b^2$$

in which ρ represents the air density, which can be assumed to be 1.25 kg/m^3 (actually, this figure exhibits a certain degree of variability, depending on numerous climatic factors); v_b indicates the calculation wind velocity, while C_e is the so-called exposure coefficient, calculated at the reference altitude, z_e , and defined as:

$$C_e(z_e) = C_r^2(z_e) \cdot C_0^2(z_e) \cdot [1 + 7 \cdot I_v(z_e)]$$

which also contains the roughness coefficient C_r , the topography factor C_0 and the turbulence intensity I_v . The topography factor, introduced in order to account for any significant local variations in the site's topography, can usually be assumed to equal unity. I_v and C_r , instead, are defined by the following relations:

$$I_v(z_e) = \begin{cases} \frac{k_I}{C_0(z_e) \cdot \ln\left(\frac{z}{z_0}\right)} & \text{se } z_{\min} < z \\ I_v(z_{\min}) & \text{se } z_{\min} \geq z \end{cases}$$

$$C_r(z_e) = \begin{cases} k_r(z_e) \cdot \ln\left(\frac{z}{z_0}\right) & \text{se } z_{\min} < z \\ C_r(z_{\min}) & \text{se } z_{\min} \geq z \end{cases}$$

where k_I is a turbulence factor, usually set to a value of one, while k_r , z_0 and z_{\min} are quantities defined as a function of the site's exposure category. As stated, the bridge in question is located in an extra-urban setting and can therefore be classified in category 4 (that is, a setting characterised by little vegetation and isolated obstacles); hence, we have the values $z_0 = 0.050 \text{ m}$, $z_{\min} = 2.0 \text{ m}$, $k_r = 0.213$. The reference height z_e represents the altitude at which the midline of the bridge's profile lies (figure 5). Recalling that the intrados of the structure is 20.0 m above ground level, we now have $z_e = 20.0 \text{ m} + (3.80/2) \text{ m} = 21.90 \text{ m}$.

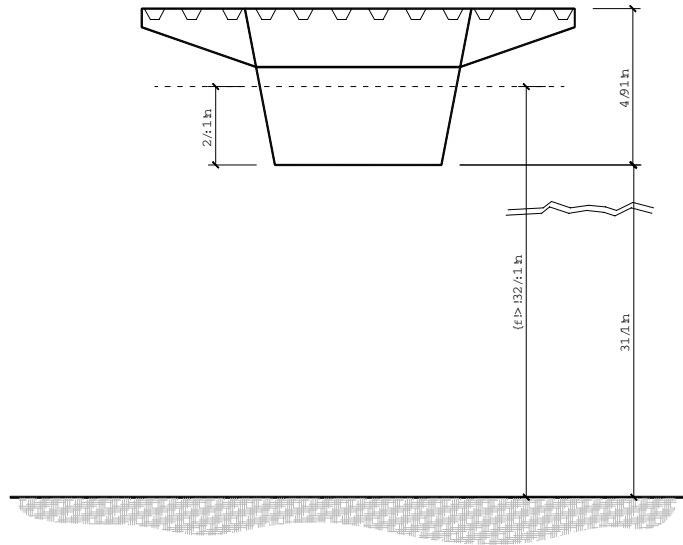


Figure 5: definition of z_e , the bridge's equivalent height, with the aim of evaluating wind actions.

As $z_e > z_{min}$, we calculate:

$$I_v(z_e) = \frac{1}{10 \cdot \ln\left(\frac{2190 \cdot \text{m}}{0.05 \cdot \text{m}}\right)} = 0.164$$

$$C_r(z_e) = 0.213 \cdot \ln\left(\frac{2190 \cdot \text{m}}{0.05 \cdot \text{m}}\right) = 1.296$$

whence:

$$C_e(z_e) = 1.296^2 \cdot 1.0^2 \cdot [1 + 7 \cdot 0.164] = 3.608$$

Now, assuming a wind velocity, $v_b = 27 \text{ m/s}$, we arrive at the equivalent pressure:

$$q_p(z_e) = 3.608 \cdot \frac{1.25}{2} \cdot 27.0^2 = 1643895 \text{ N/m}^2 \cong 1.644 \text{ kN/m}^2$$

Following the notation adopted in Eurocode 1 part 1-4 (EN 1991-1-4: "Actions on structures. General actions. Wind actions"), by which 'x' indicates the horizontal direction orthogonal to the bridge's axis, the force acting on the bridge along this direction is given by:

$$F_{w,x} = q_p(z_e) \cdot C_{f,x} \cdot A_{ref,x}$$

The coefficient $C_{f,x}$ is a function of the ratio of the deck's height to its width. Regardless of the

presence of the two safety barriers, we have the ratio $d/b = (10.50 \text{ m}) / (3.80 \text{ m}) = 2.76$, to which corresponds the value of $C_{f,x} = 1.666$.

This coefficient can be reduced on the basis of the fact that the lateral walls of the box girder are not vertical, but inclined at an angle α (figure 6). The reduction consists of decreasing the value of coefficient $C_{f,x}$ by 0.5% for each exagesimal degree of inclination of the lateral plates. Since $\alpha = 11.16^\circ$, we can reduce the coefficient $C_{f,x}$ by a total of $0.5\% \times 11 = 5.5\%$ and thus in conclusion assume $C_{f,x} = 1.666 \times 0.945 = 1.574$.

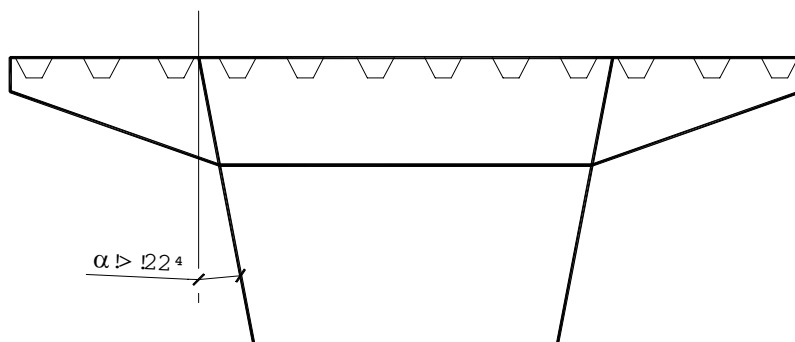


Figure 6: inclination angle α of the lateral walls of the box girder, enabling a reduction in the value of coefficient $C_{f,x}$.

When calculating the reference area on which the wind acts in direction 'x', we must account for the presence of the two safety barriers. To this end, Eurocode 1 calls for adding 60 cm to the deck's height, and then calculating the area $A_{ref,x}$ via the formula:

$$A_{ref,x} = (380 \text{ cm} + 60 \text{ cm}) \cdot L = 4.40 \text{ m} \cdot L$$

where L is the length of the bridge.

Expressing the transverse horizontal wind action as a uniformly distributed load per unit length, we obtain:

$$F_{w,x} = q_p(z_e) \cdot C_{f,x} \cdot A_{ref,x} = 1.644 \text{ kN/m}^2 \cdot 1.574 \cdot 4.40 \text{ m} = 1139 \text{ kN/m}$$

As far as the vertical action is concerned, lacking more precise data from wind tunnel tests, a value of ± 0.9 can be assumed for the coefficient $C_{f,z}$, with the '+' or '-' sign chosen so as to assume the least favourable situation. The reference area in this case is the horizontal projection of the bridge deck,

$$F_{w,z} = q_p(z_e) \cdot C_{f,z} \cdot A_{ref,z} = 1.64 \text{ kN/m}^2 \cdot (\pm 0.9) \cdot 10.50 \text{ m} = \pm 15.50 \text{ kN/m}$$

an action which must be applied with eccentricity, e , with respect to the longitudinal axis of the bridge, defined as:

$$e = \frac{d}{4} = \frac{10.50 \text{ m}}{4} = 2.625 \text{ m}$$

Finally, in the 'y' direction (the bridge's longitudinal axis), we must provide for an action equal to the 25% of that taken for the direction orthogonal to the axis.

2.5 Thermal actions

As the structure under consideration is a continuous beam resting on four supports, stresses are induced by thermal variations, as well as by displacements and stresses. In order to account for thermal variations during the stage of calculation, two different contributions must be distinguished: a uniform thermal variation along the section and a temperature gradient through the straight section's width (indicative of the fact that the bridge intrados and extrados may be at different temperatures because of differential heating or cooling effects). The former does not provoke any stresses as long as the bridge can slide horizontally in correspondence to its supports and will cause only a shortening or elongation of the structure's line of axis. The second effect is instead more significant. Eurocode 1, part 5, offers two possible procedures to deal with it: the first, more rigorous one, calls for applying a rather complex thermal variation law to the section's thickness (figure 7), while the second instead makes use of a simpler linear variation. Consequently, while the first variation law requires employing dedicated software for the structural analysis, the linear variation relation, on the other hand, enables calculations to be performed manually, at least to a certain degree. In the case of steel deck structures, regulations call for a uniform thermal variation of 20 °C and, regarding the linear variation, a raise in temperature of 18 °C at the extrados with respect to the intrados, and an increase of 13 °C at the intrados with respect to the extrados (figure 8).

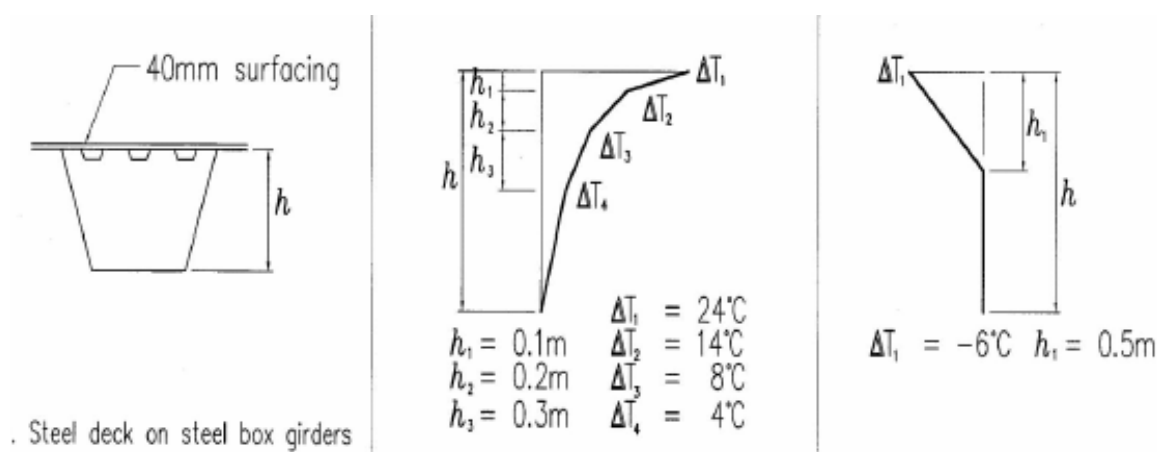


Figure 7: temperature distribution at the height of the box girder following the most rigorous approach.

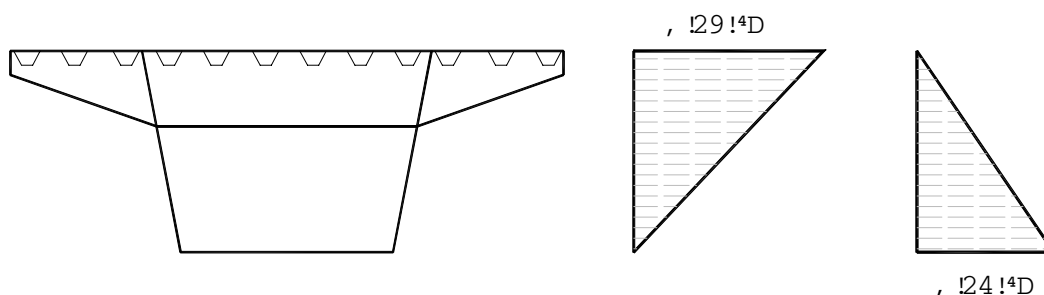


Figure 8: temperature gradients following the simplified approach

3 CALCULATING THE STRESSES

3.1 Behaviour of the structure

The structural behaviour of the steel decks employing an orthotropic plate can be best described by distinguishing three separate resistant functions for the structure, each of which having a unique corresponding systems of stresses and deformations.

The deck plate, first of all, has the function of transferring the loads impinging directly upon it to the underlying stiffening ribs. Thus, the safety of the deck under the action of local loads must be checked. To this end, the overall structure in question must be regarded as an actively resistant orthotropic deck (the deck plate collaborates with the ribbing, to which it is consolidated) that transfers the loads to the constituent plates of the box girder walls.

Lastly, it is necessary to evaluate the effects of the loads on the individual elements of the orthotropic deck, (deck plate, longitudinal stiffeners, transverse beams) when the deck, as the upper-most element of the principal structure, contributes to the overall resistance of the structure by absorbing the stresses.

3.2 Local effects on the deck plate

Usually the stress effects of the first of the aforementioned behaviours are not considered, because of the advantageous combined effects of local plasticisation of the materials and a membrane-type behaviour (at collapse thresholds, in fact, the deck plate behaves very much like a tense membrane between two cylindrical hinges, which are the connections fastening it to the underlying stiffening elements).

However, if an evaluation of such stress states is desired, the area subjected to the contact pressure of the wheel in the Load Model must be determined. Eurocode LM1 calls for wheels with footprints of 0.40 m x 0.40 m. Given a surfacing with overall thickness of 60 mm, and then supposing a 45° dispersion of the stresses, the load of the single wheel covers an area of 0.52 m x 0.52 m (figure 9).

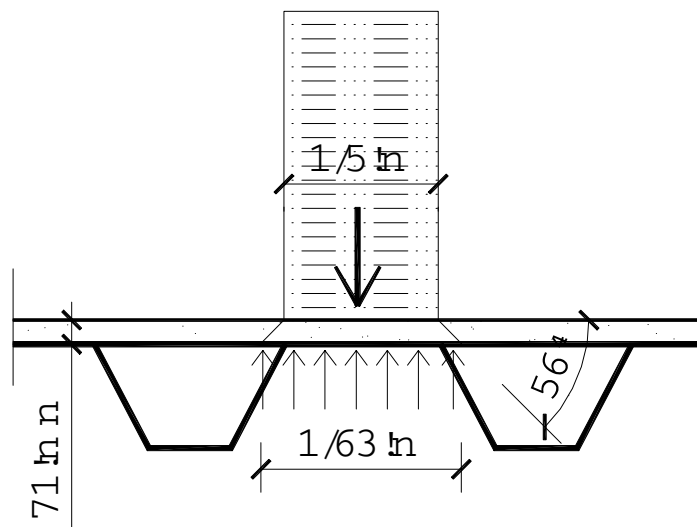


Figure 9: footprint of the load from a single wheel

Thus, the relative contact pressure of a single wheel on the first conventional lane is:

$$p_{Q1} = \frac{150 \text{ kN}}{52 \text{ cm} \cdot 52 \text{ cm}} = \frac{150 \text{ kN}}{2704 \text{ cm}} = 554.7 \text{ kN/m}^2$$

Local stress are very important concerning with fatigue: this aspect can be determinant for design of deck, closed ribs and slots, but we don't treat it in this example.

3.3 Calculation methods for the orthotropic deck

Analysing the stresses on the orthotropic deck, considered to be a two-dimensional resistant element that transfers the loads to the walls of the box girder, is not a simple task.

A first possible procedure consists of implementing a finite-element model, made up essentially of "shell" elements, which reproduce a significant portion of the deck so that the actual effects on the orthotropic deck can be determined. Figure 10 illustrates an example of an FEM model.

Alternatively, it is possible to apply simplified calculation models. Although all the calculation procedures available in the literature are based on defining an equivalent orthotropic deck, they can be divided into two types depending upon whether both the longitudinal and transverse ribbing are taken into account in calculating the equivalent deck's stiffness, or only the longitudinal ribbing is considered. The former includes, for instance, the Cornelius method, while the Pelikan-Esslinger method represents the best example of the second approach because of its wide-spread application and the precision of the results it yields. A detailed examination of the calculation methods for orthotropic plates is beyond our present scope. We are rather concerned with defining the actions to impose on the structure. Regardless of the calculation method adopted (FEM modelling or simplified closed-form calculations), a limited deck width can be considered, for instance less than that of a conventional lane. This surface is then subjected to the loads producing the greatest effects, that is, those of first load lane in the LM1 model (the

concentrated loads of the wheels are presented as distributed pressures on the calculated footprint while taking the thickness of the surfacing into account).

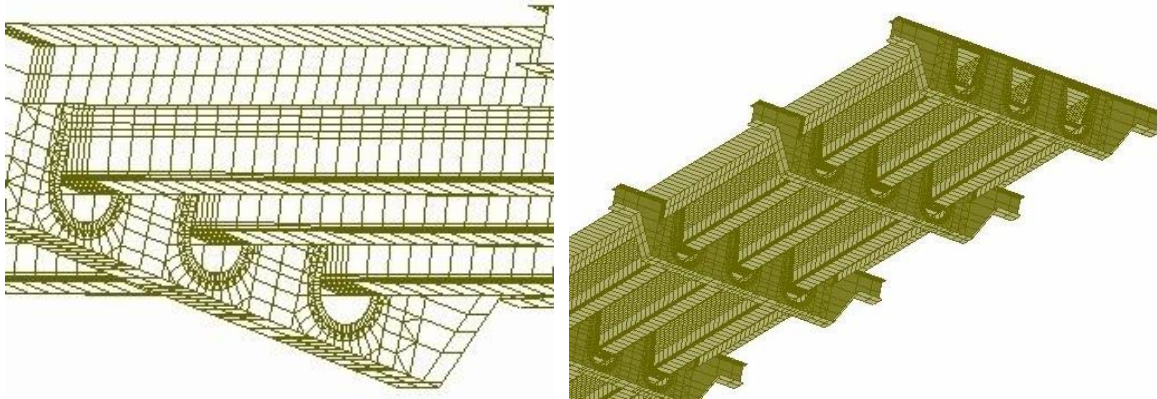


Figure 10: example FEM model of a portion of an orthotropic deck with closed trapezoid-shaped ribs.

3.4 Calculating the main structure

The main structure is calculated simply as a continuous beam resting on four supports, with flexional stiffness equal to that of the box girder in its entirety, therefore also considering the presence of the longitudinal gutters ($J = 0.94462 \text{ m}^4$).

3.4.1 The effects of self-weight and dead loads

The structure's own weight and permanent loads altogether produce a dead load of:

$$g_b + g_p = 3195 \text{ kN/m} + 23.10 \text{ kN/m} = 55.05 \text{ kN/m}$$

which yields the symmetrical diagram of bending moments shown in figure 11.

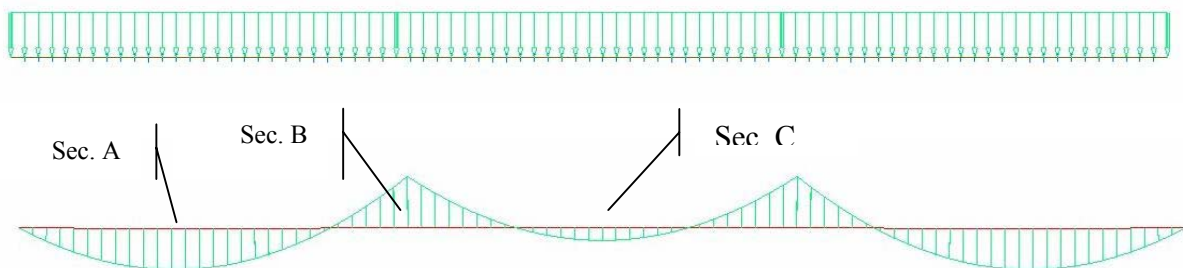


Figure 11: bending moments due to dead loads.

$$M_g(A) = \frac{2}{25} \cdot (g_b + g_p) \cdot L^2 = \frac{2}{25} \cdot 55.05 \text{ kN/m} \cdot (1200 \text{ m})^2 = 634176 \text{ kNm}$$

$$M_g(B) = \frac{-1}{10} \cdot (g_b + g_p) \cdot L^2 = \frac{-1}{10} \cdot 55.05 \text{ kN/m} \cdot (1200 \text{ m})^2 = -792720 \text{ kNm}$$

$$M_g(C) = \frac{1}{40} \cdot (g_b + g_p) \cdot L^2 = \frac{1}{40} \cdot 55.05 \text{ kN/m} \cdot (1200 \text{ m})^2 = 198180 \text{ kNm}$$

3.4.2 The effects of traffic loads

The effects of Load Model 1 are at a maximum, in terms of main beam bending, when loads are present transversally on all three conventional lanes of the roadway as well as the residual area. The distributed load and tandem axles are therefore:

$$q = (7.2 + 2.5 + 2.5) \text{ kN/m}^2 \cdot 3.0 \text{ m} + 2.5 \text{ kN/m}^2 \cdot 1.5 \text{ m} = 40.35 \text{ kN/m}$$

$$Q = 2 \cdot [(Q_1 \cdot 2) + (Q_2 \cdot 2) + (Q_3 \cdot 2)] = 2 \cdot [(240 \cdot 2) + (200 \cdot 2) + (100 \cdot 2)] \text{ kN} = 1080 \text{ kN}$$

The last expression involves the implicit assumption that a single concentrated force represents the 12 forces corresponding to the wheels of the two pairs of tandem axles on each lane. In fact, in order to evaluate the bending moment in the main beam, the transverse distribution of the loads is not important, though it is indeed relevant to the aim of determining torsion effects. The assumption errs on the side of greater safety and, in any event, furnishes values of the bending moments in the beam very near those obtainable through rigorous procedures.

For the concentrated load, we have the situation illustrated in figure 12.

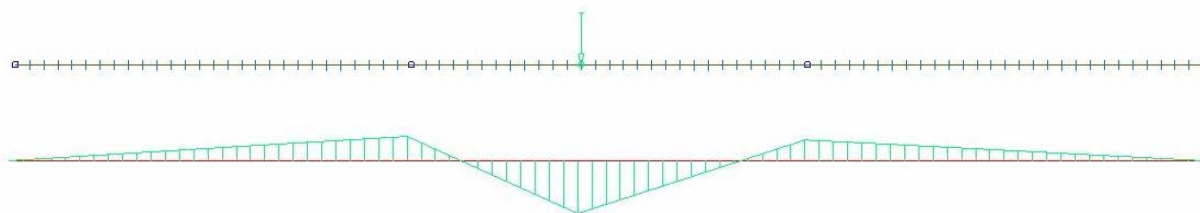


Figure 12: diagram of the bending moment due to the concentrated loads of LM1, arranged in the midline of the central span.

Following the same notation, by which A, B and C, respectively indicate the midline section of the first span, the section in correspondence to the first support and the midline section of the central span, we obtain the following values:

$$M_Q(B) = \frac{-3}{40} \cdot Q \cdot L = \frac{-3}{40} \cdot 1080 \text{ kN} \cdot 1200 \text{ m} = -9720.0 \text{ kNm}$$

$$M_Q(C) = \frac{7}{40} \cdot Q \cdot L = \frac{7}{40} \cdot 1080 \text{ kN} \cdot 1200 \text{ m} = 22680.0 \text{ kNm}$$

Regarding the distributed load, longitudinally it must be distributed so as to maximize the sought-after effects according to the theory of influence lines, thus considering the following load conditions:

- Maximum positive moment in the central span:

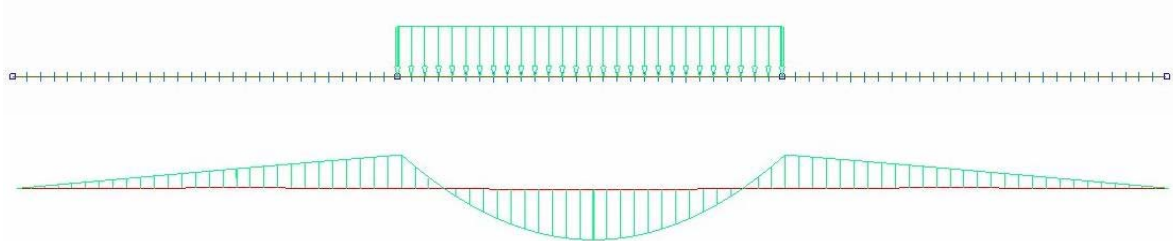


Figure 13: arrangement of the distributed traffic load maximizing the positive moment in the central span.

$$M_q(C) = \frac{3}{40} \cdot q \cdot L^2 = 43578.0 \text{ kNm}$$

- Maximum positive moment in the two lateral spans:

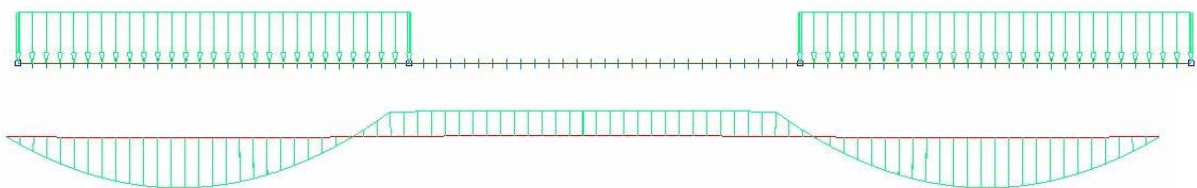


Figure 14: arrangement of the distributed traffic load maximizing the positive moment in the two lateral spans.

$$M_q(A) = 58833.0 \text{ kNm}$$

- Maximum negative moment in absolute value on the support.

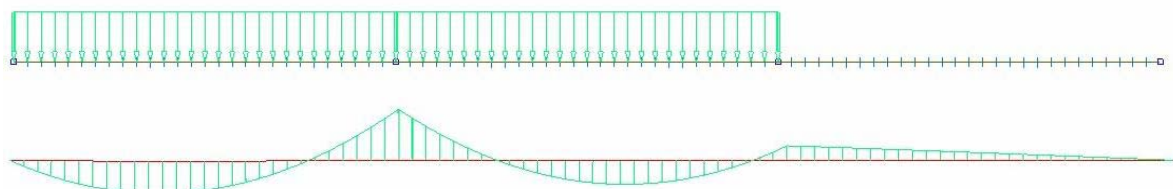


Figure 15: arrangement of the distributed traffic load to determine the maximum negative bending moment in absolute value on the first intermediate support.

$$M_q(B) = -677265 \text{ kNm}$$

3.4.3 Wind effects

The vertical component of the pressure exerted by the wind, acting on the entire expanse of the bridge, determines a bending moments diagram wholly analogous to that due to the dead loads. Calculations yield the following significant values:

$$M_w(A) = \frac{2}{25} \cdot q_w \cdot L^2 = \frac{2}{25} \cdot 1550 \text{ kN/m} \cdot (1200 \text{ m})^2 = 178560 \text{ kNm}$$

$$M_w(B) = \frac{-1}{10} \cdot q_w \cdot L^2 = \frac{-1}{10} \cdot 1550 \text{ kN/m} \cdot (1200 \text{ m})^2 = -223200 \text{ kNm}$$

$$M_w(C) = \frac{1}{40} \cdot q_w \cdot L^2 = \frac{1}{40} \cdot 1550 \text{ kN/m} \cdot (1200 \text{ m})^2 = 55800 \text{ kNm}$$

3.4.4 Effects of thermal variations

A linear thermal variation through the thickness of the section produces a bending moment diagram that is linearly increasing in the two side spans and constant in the central one (figure 16).

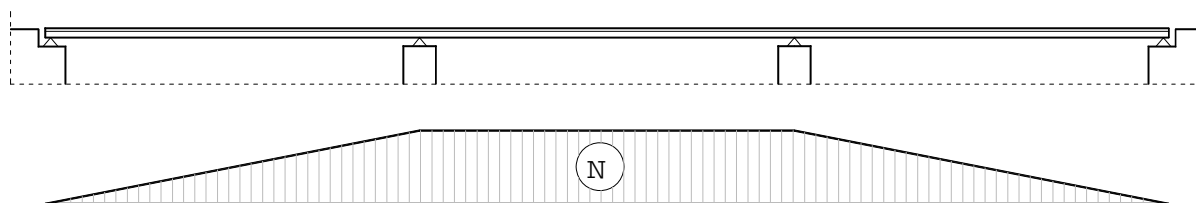


Figure 16: diagram of the bending moment for a linear temperature gradient through the section's thickness.

The upper fibres are under tension when the extrados is colder than the intrados and, vice versa, the inferior ones are tensed (positive bending moment) if the extrados is warmer than the intrados.

- 1° case: T extrados-T intrados = + 18 °C

$$M_{\Delta T} = \frac{\alpha \cdot \Delta T}{h} \cdot \frac{6 \cdot EJ}{5} = 135309 \text{ kNm}$$

where $h = 3.8 \text{ m}$ indicates the beam's, and $\alpha = 1.2 \times 10^{-5} \text{ } ^\circ\text{C}^{-1}$ is the steel's linear thermal expansion coefficient.

- 2° case: T intrados-T extrados = + 13 °C

$$M_{\Delta T} = \frac{-\alpha \cdot \Delta T}{h} \cdot \frac{6 \cdot EJ}{5} = -97723 \text{ kNm}$$

Ulterior developments could be made if, in relation to local site condition, it is necessary to hold account of the non-linear thermal gradient, as described in 3.5.

3.5 Calculating the transverse section

Calculation of the constituent parts of the box girder is performed by initially considering the orthotropic deck to be perfectly fixed at the extremities and then loading the box girder with the opposite sign reactions of perfect fixation (figure 17).

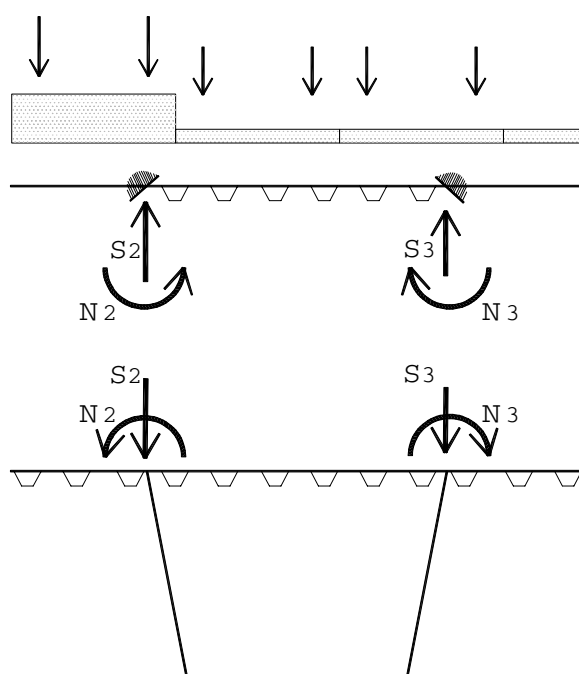


Figure 17: calculation of the box girder.

If, for instance, one wants to study the maximum torsional effects of the traffic load, the load must be applied, not throughout the entire transverse expanse of the roadway, but only in the zones indicated in the following figure.

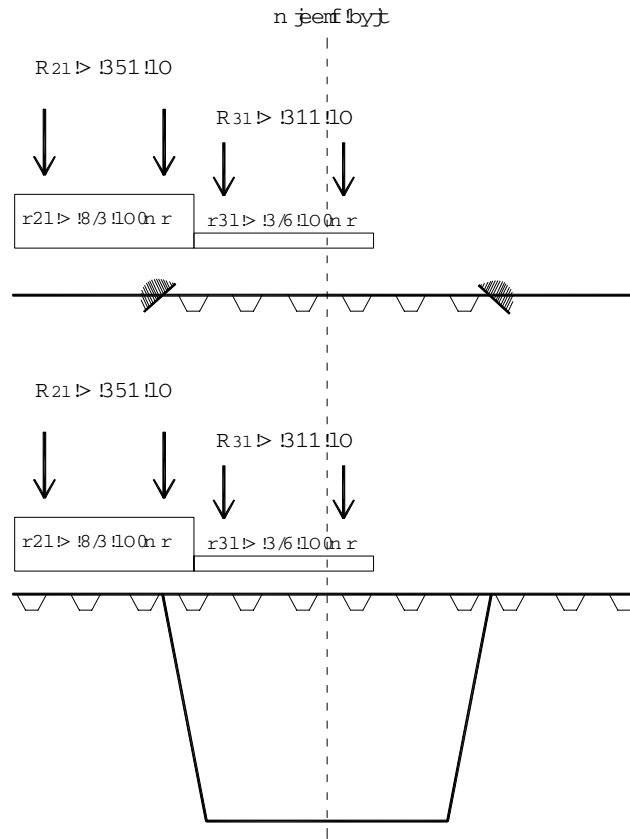


Figure 18: transverse arrangement of the loads for determining the maximum torsion in the box girder.

In this analysis stage, it is also necessary to account for the wind pressure component orthogonal to the bridge's axis line, also considering the presence of the safety barriers (already considered in the stage of defining wind actions). The pressure is expressed as a load distributed along the height:

$$F_{w,x} = q_p(z_e) \cdot C_{f,x} = 1.644 \text{ kN/m}^2 \cdot 1.574 = 2.59 \text{ kN/m}$$

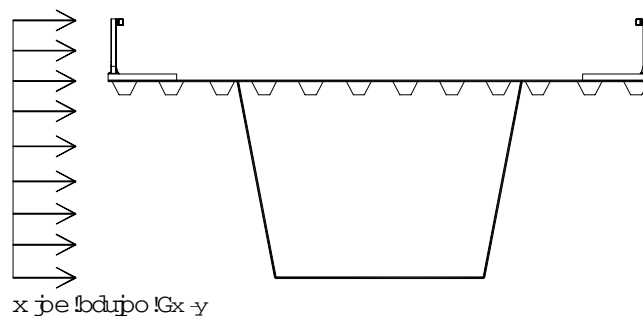


Figure 18: application of the transverse component of the wind pressure, without load traffic on bridge.

A second case considers the presence of vehicles on the bridge, with conventionally 2.0 m high profiles.

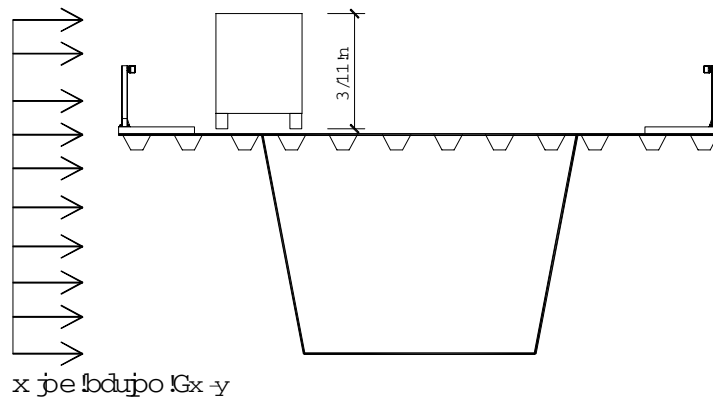


Figure 19: application of the transverse component of the wind pressure, with load traffic on bridge.

For the purposes of the present example, that aims to illustrate the application modalities of EN 1991-2, Traffic loads on bridges, profit is not thought to develop beyond the design calculations of the bridge.

CHAPTER 5: EXAMPLE OF A STEEL FOOTBRIDGE

Igor Kovše¹

¹Institute of Metal Constructions, Ljubljana, Slovenia

Summary

The example includes the determination of loads and load combinations on the steel footbridge, according to the European constructional standards “Eurocodes”. The bridge is a steel suspension bridge used for pedestrian and cycle traffic. The relevant loads acting on the structure are determined from the appropriate parts of European standards and load combinations required for the ultimate and serviceability limit states verification are given.

1 INTRODUCTION

An example of the steel footbridge used for pedestrian and cycle traffic is presented in this chapter. The emphasis of this example is on the determination of the relevant loads and load combinations according to European standards “Eurocodes”. The verification presented here is not complete and is meant to be an indication on how to proceed with the use of the material (steel) specific Eurocodes, after the effects of actions due to load combinations are obtained.

1.1 Background materials

The determination of the permanent and variable loads – traffic loads, imposed loads, snow loads and wind loads are treated in the relevant parts of the European standard EN 1991-1: EN 1991-2 [2], EN 1991-1-3 [3] and EN 1991-1-4 [4]. The verification of steel members is covered in detail in the steel-specific European standard EN 1993-1-1 [5]. Further information is available in the working material of JCSS [6] and specialized literature.

2 DEFINITION OF THE SYSTEM

2.1 The structural system

The bridge presented in this example is a suspension steel footbridge with the main span of 30 meters and two ending spans of 7 meters (see figure 1). The bridge is suspended on two steel cables. The steel cables are supported by two pylons with the height of 7 m above the concrete bases. The ends of the steel cables are connected to the transverse steel beam, which is anchored into the rock. The bridge deck is hanging on the suspension cables and is connected to them by steel hangers, which are located every 3 meters. The bridge girder is a continuous structure made of steel profiles with bolted connections. The girder is supported by the hangers every 3 m, except at both ends between the pylons and cable anchorage points. At these locations the structure of the girder is a simple supported beam of the same structure as the main continuous girder, but strengthened with additional plates at the bottom. The wind bracing is positioned at the bottom of the girder. The parapets are supported by steel box profiles. In the transverse direction the main girder is stabilized with 8 steel cables which are anchored into the ground. The pylons act as consoles in the longitudinal direction. In the transverse direction the

structure of the pylons is a steel frame with transverse beams at the top and below the main girder. The pylons are rigidly connected to concrete bases.

2.2 Properties of the sections

The suspension cables are wire ropes with the diameter 40 mm and with the yield strength $\sigma_{0,2}=1420$ MPa. The cables for transverse stability have the diameter 16 mm and the yield strength $\sigma_{0,2}=1570$ MPa. The hangers are steel rods with diameter 20 mm. The 3 m long sections of the main girder are made of two longitudinal steel profiles H 150x150x14 mm and two transverse steel profiles H 50x50x5 mm. Continuity of the girder is assured by bolted connections of longitudinal H profiles. The pylons are welded box sections with plate thickness 10 mm and 12 mm. The parapets are made of 50x50 mm box sections with the thickness 5 mm. The material of the profiles is constructional steel S 235 with the yield stress

$$f_y = 235 \text{ N/mm}^2 \quad (1)$$

The geometrical properties of the section are given in the table 1.

Table 1. Geometrical properties of the steel sections.

Element	Section	A [cm ²]
main cable	φ 40 mm	12,6
lateral cables	φ 16 mm	2,0
hangers	φ 20 mm	3,1
longitudinal profile	H 150x150x15 mm	43,0
transverse profile	H 50x50x5 mm	4,8
wind bracing	tube φ 51x 3,6mm	5,4
parapet	50x50, t=5mm	9,0

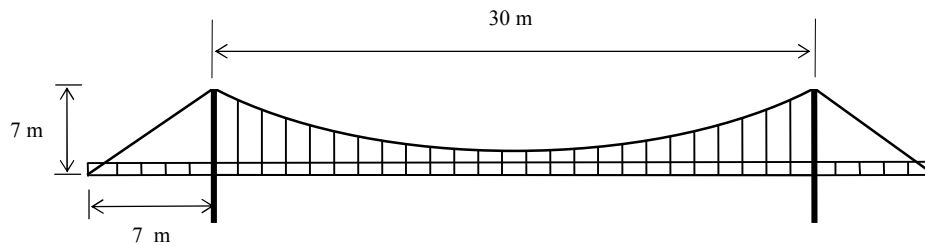


Figure 1. View of the structural system of the footbridge.

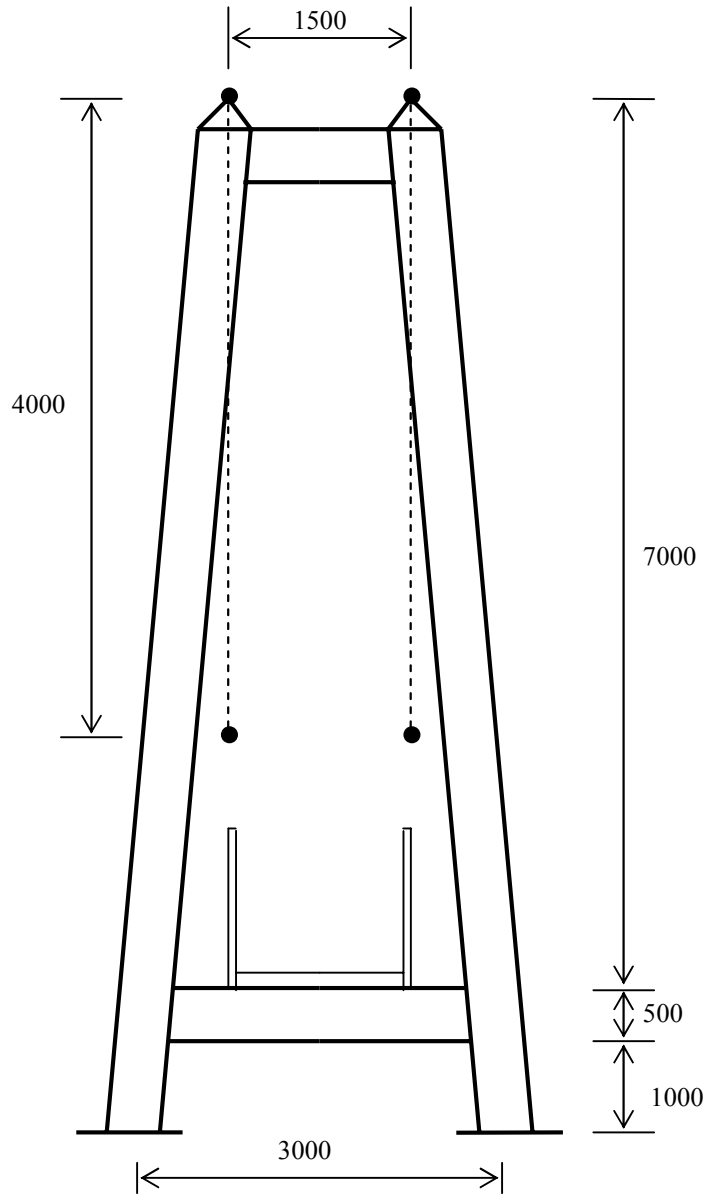


Figure 2. View of the pylon of the footbridge.

3 DEFINITION OF THE ACTIONS

3.1 Permanent actions

According to EN 1991-1-1 [2], the self weight of the structural elements and the deck surface is classified as a permanent fixed action.

3.1.1 Self weight of structural members

Self weight of the steel members is calculated from the nominal dimensions of the members (the cross section area A) and the characteristic value for the density of steel γ . The densities of structural materials are given in the standard EN 1991-1-1 [2] with their mean value or with the range of mean values. If the range of mean values is given, the value chosen should

depend on the knowledge of the source and quality of the material for individual project. The mean value chosen is taken as a characteristic design value. For structural steel the density γ is given (EN 1991-1-1, Appendix A) in the range 77,0 kN/m³ to 78,5 kN/m³. In this example we choose the value

$$\gamma = 78,5 \text{ kN/m}^3 \quad (2)$$

Based on this characteristic value, the self weight per unit length g_k , for the steel profiles and cables is calculated according to formula

$$g_k = \gamma A \quad (3)$$

The self weight of structural members is calculated as distributed load per longitudinal meter and is given as follows. For the hangers, transverse beams, wind bracing and parapet the actual number of elements per longitudinal meter is taken into account. The table 2 gives the calculated characteristic values of self weight.

Table 2. Self weight per unit length of the footbridge.

Element	Section	g_k [kN/m]
main cable	ϕ 40 mm	0,099
lateral cables	ϕ 16 mm	0,016
hangers	ϕ 20 mm	0,024
longitudinal profile	H 150x150x15 mm	0,34
transverse profile	H 50x50x5 mm	0,038
wind bracing	tube ϕ 51x 3,6mm	0,042
parapet	50x50, t=5mm	0,071

3.1.2 Deck cover

The deck is covered with wooden boards of thickness 5 cm. According to EN 1991-1-1, Appendix A, we take the characteristic design value for the density γ for timber strength class C40 be 5,0 kN/m³. Considering the width of the footbridge, $W = 1,5$ m, we compute the distributed weight of the deck cover per unit length:

$$g_{deck} = 1,5 \cdot 0,05 \cdot 5,0 = 0,38 \text{ kN/m} \quad (4)$$

3.2 Snow loads

According to EN 1991-1-3 [3], the snow loads are classified as a variable fixed action. The Slovenian national annex to EN 1991-1-3 [3] gives the table of characteristic values of the ground snow load s_k for the relevant altitude and load zone (table 3).

The footbridge in this example is located in Slovenia at the altitude 250 m in the snow load zone C. The interpolation from the values in table 3 gives us the characteristic value of the ground snow load at this location:

$$s_k = 1,8 \text{ kN/m}^2 \quad (5)$$

The exposure coefficient C_e is normally taken equal to 1,0, but in our case of a footbridge over the river exposed on all sides, we choose the value 0,8 for this coefficient. This is the recommended value for “windswept” conditions, according to table 5.1 of EN 1991-1-3 [3]. The normal value of the thermal coefficient C_t equal to 1,0 is assumed.

Table 3: Characteristic values of the ground snow load s_k [kN/m²] for Slovenia.

altitude [m]	Snow load zone			
	A	B	C	D
0	0,25	-	-	-
100	0,25	1,4	1,7	-
200	0,50	1,4	1,7	-
300	0,75	1,5	1,9	3,0
400	1,00	1,6	2,1	3,0
500	1,20	1,7	2,3	3,5
600	1,60	1,8	2,7	4,0
700	-	2,0	3,2	4,5
800	-	2,2	3,7	5,0
900	-	2,4	4,2	6,0
1000	-	2,7	5,4	7,5
1100	-	3,0	6,2	9,0
1200	-	3,3	7,0	10,5
1300	-	3,6	7,8	12,0
1400	-	3,9	8,6	13,5
1500	-	4,2	9,2	15,0

The snow load shape coefficients μ are dependent on the shape of the roof, or the bridge deck in our case. For a horizontal deck, $\alpha = 0^\circ$, this coefficient is equal to 0,8.

The snow load on the footbridge deck is obtained from the formula:

$$s_{deck} = \mu \cdot C_e \cdot C_t \cdot s_k = 0,8 \cdot 0,8 \cdot 1,0 \cdot 1,8 = 1,15 \text{ kN/m}^2 \quad (6)$$

And the snow load per unit length of the footbridge is:

$$s = s_{deck} \cdot W = 1,15 \cdot 1,5 = 1,73 \text{ kN/m} \quad (7)$$

3.3 Wind loads

According to EN 1991-1-4 [4] (Eurocode on wind actions) for footbridges up to 30 m of span the wind loads can be calculated using the simpler, quasi-static procedure. The first step in this procedure is to determine the basic wind velocity v_b . The most part of Slovenia, including the location of the bridge in this example, is located in the zone with reference wind velocity $v_{b,0} = 25 \text{ m/s}$. Using the usual value 1,0 for the directional factor c_{dir} and seasonal factor c_{sea} , the basic wind velocity is

$$v_b = v_{b,0} \cdot c_{dir} \cdot c_{sea} = 25 \text{ m/s} \quad (8)$$

The mean wind velocity $v_m(z)$ at the height z is calculated from the base wind velocity and two factors $c_o(z)$ and $c_r(z)$. The orography factor $c_o(z)$ takes into account the changes in terrain. Since the footbridge is situated in smooth flat country, we choose the value 1,0. The roughness factor $c_r(z)$ accounts for height of the structure and roughness of the terrain and is calculated by

$$c_r(z) = k_r \ln(z / z_0), \quad z_{min} < z < 200 \text{ m} \quad (9)$$

where we have $k_r = 0,19$, $z_0 = 0,05$ m and $z_{\min} = 4$ m for terrain category II (farmland with boundary hedges). Knowing the height of the midline of the bridge above the terrain, $z = 5$ m, we obtain the mean wind velocity

$$v_{\min}(z) = c_r(z) c_o(z) v_b = 0,19 \ln(5/0,05) \cdot 1,0 \cdot 25 = 21.9 \text{ m/s} \quad (10)$$

Next we determine the peak velocity pressure $q_p(z)$ from the equation

$$q_p(z) = \left[1 + 7 \frac{k_I}{c_o(z) \ln(z/z_0)} \right]^{1/2} \rho v_m^2(z) = 0,755 \text{ kN/m}^2 \quad (11)$$

In the above equation ρ is the air density (in most regions $\rho = 1,25 \text{ kg/m}^3$) and k_I is the turbulence factor, which is in general equal to 1,0.

According to EN 1991-1-4 [4] the wind load on bridges is divided in three components: wind forces in the direction perpendicular to the bridge axis (“x-direction”), parallel to the bridge axis (“y direction”) and in the vertical direction (“z-direction”).

The wind force acting on the bridge in x-direction is given by:

$$F_{w,x} = q_p(z) \cdot C_{f,x} \cdot A_{\text{ref},x} \quad (12)$$

where $C_{f,x}$ is the force coefficient and $A_{\text{ref},x}$ is reference area on which the wind in the x-direction is acting. For open-type or trussed girders with the parapets on both sides the reference area is the height of the bridge deck with the addition of 600 mm for the influence of open parapets. With reference to the cross section of the bridge deck in figure 3, this reference area is given by

$$A_{\text{ref}} = (b + 600 \text{ mm}) \cdot L = 0,85 \text{ m} \cdot L \quad (13)$$

where L is the length of the bridge.

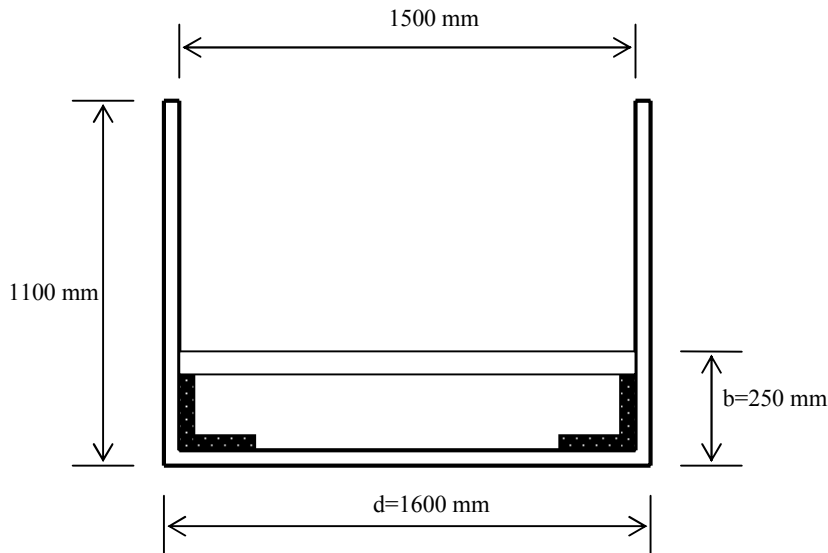


Figure 3. Schematic view of the bridge deck cross section.

The coefficient $C_{f,x}$ is dependent of the ratio d/b between the width and height of the bridge deck. For the ratio $d/b = 1600/1100 = 1,45$ this coefficient is $C_{f,x} = 2$. It can be reduced by a slenderness reduction factor ψ which is equal to 0,95 for the effective slenderness of the bridge, $L/b = 30/0,25 = 120$. The wind force acting on the bridge in x-direction is then by equation (12) given by:

$$F_{w,x} = 0,755 \cdot 2 \cdot 0,95 \cdot 0,85 \cdot L = 1,22 \text{ kN/m} \cdot L \quad (14)$$

The wind force in the z-direction (vertical force) is obtained using the force coefficient $C_{f,z} = 0,15$ for the inclination angle of the bridge deck equal to 0. The reference area for this direction is $A_{\text{ref},z} = d \cdot L$

$$F_{w,z} = 0,755 \cdot 0,15 \cdot 1,6 \cdot L = 0,18 \text{ kN/m} \cdot L \quad (15)$$

The wind force in the y-direction (longitudinally) is taken as 25 % of the wind force in x-direction. Wind forces on the pylons are calculated from the area of the pylon perpendicular to the wind direction, $A_{p,x} = 0,5 H$ and the force coefficient for rectangular sections, which is 2,1 for the ratio $d/b=1$ of the pylon:

$$F_{p,x} = 0,755 \cdot 2,1 \cdot 0,5 \cdot H = 0,79 \text{ kN/m} \cdot H \quad (16)$$

3.4 Thermal loads

The thermal actions are defined as a uniform temperature change over the whole gross section of the bridge as well as temperature gradient across the height of the bridge deck. Due to small deck height only the uniform temperature gradient of $\Delta T=20^\circ \text{C}$ is considered here.

3.5 Traffic loads

According to EN 1991-2 [5] the traffic loads are considered as imposed loads and are classified as variable or accidental actions. For normal use the traffic and pedestrian loads are considered as variable loads.

Imposed loads on footbridges due to traffic are the actions caused by pedestrian and cycle traffic, minor constructional loads, possibly a load due to specific vehicle (e.g. maintenance vehicle) and accidental actions. The load models defined in EN 1991-2 include dynamic amplification factors.

Vertical loads on footbridges include three types of loads which are mutually exclusive, i.e. only one of them is considered in a certain combination of loads. These types are: (a) uniformly distributed loads; (b) concentrated load; and (c) load representing service vehicle. The characteristic value of the uniformly distributed load is in general defined as $q_{fk} = 5 \text{ kN/m}^2$. However, for spans greater than 30m this load is given by

$$q_{f_{wk}} = 2,0 + 120/(L+30) = 2,0 + 120/(30+30) = 4 \text{ kN/m}^2 \quad (17)$$

The distributed load per unit length for the footbridge in question is

$$q_w = 4 \cdot 1,5 = 6 \text{ kN/m} \quad (18)$$

The characteristic value of the concentrated load is equal $Q_{fwk} = 10 \text{ kN}$ and is acting on the square surface with sides $0,1 \text{ m}$. It can be taken into account only for the local verification if this can be distinguished from the global verification.

The accidental presence of the vehicle on the footbridge is considered as the accidental action if the access of such a vehicle on the footbridge is not restricted by a permanent device. If not specified otherwise the accidental load Q_A of this vehicle is represented by two-axial loading pattern with axle loads 80 kN and 40 kN (see figure 4).

Horizontal force acting on the footbridge is either 10% of the total load corresponding to the distributed force q_w or 60% of the total weight of the service vehicle Q_A and is acting simultaneously with the corresponding vertical load.

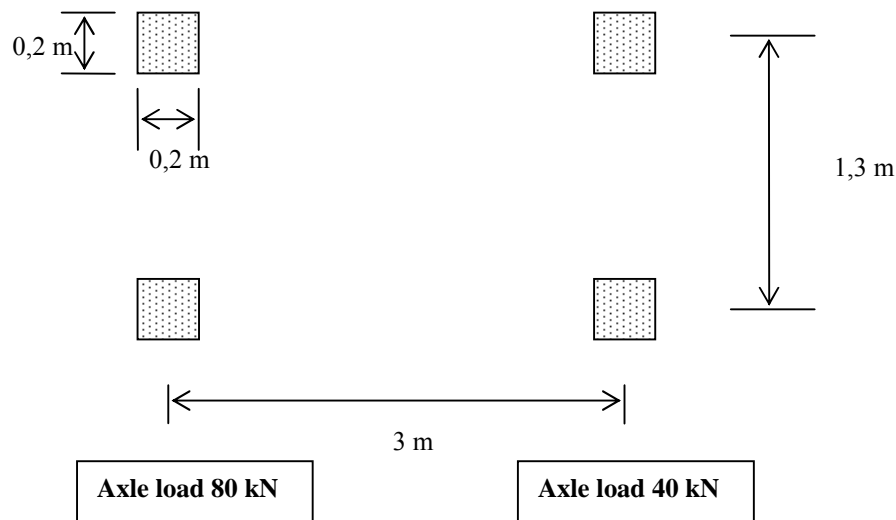


Figure 4. Accidental vehicle on the footbridge.

4 COMBINATION OF ACTIONS

The individual permanent, variable and accidental loads are used in a number of combinations in order to verify that the ultimate limit states and ultimate serviceability limit states are fulfilled. The separate actions with their symbols and types are summarized in the table 4.

Table 4: Actions on the footbridge.

Symbol	Description of the action	Type of action
G	Self weight of the structure	permanent
P	Deck cover	permanent
S	Snow load	variable
W	Wind load	variable
T	Thermal loads	variable
q	Uniform traffic load	variable
Q	Concentrated traffic load	variable
Q_A	Load due to accidental presence of a vehicle on the footbridge	accidental

4.1 Combination of action for the ultimate limit state verification

The verification of the ultimate limit state is carried out according to equation 6.8 of the Eurocode EN 1990 [1]:

$$E_d \leq R_d \quad (19)$$

where E_d is the design value of the effects of actions, such as internal force or a moment, and R_d is the design value of the corresponding resistance.

Following the guidance of EN 1990 we will distinguish two types of load combinations for the ultimate limit states: fundamental combination and the combination for accidental design situation. For the fundamental combination case, the design value of the effects of actions E_d is calculated from the combination of actions according to the equation (6.10) of the Eurocode EN 1990 [1]:

$$\sum_{j \geq 1} \gamma_{G,j} G_{k,j} + \gamma_{Q,1} Q_{k,1} + \sum_{i > 1} \gamma_{Q,i} \psi_{0,i} Q_{k,i} \quad (20)$$

where $G_{k,j}$ are characteristic values of permanent loads with corresponding partial factors $\gamma_{G,j}$ (equal to 1,35 for unfavourable effect and 1,0 for favourable effect), $Q_{k,i}$ are characteristic values of variable loads with corresponding partial factors $\gamma_{Q,j}$ (1,35 for traffic loads and 1,5 for other unfavourable variable loads and 0 for favourable), and $\psi_{0,i}$ are combination factors (0,4 for traffic loads, 0 for wind, 0 for temperature, and 0 for snow – see table D.2 in EN 1991-2 [5]). $Q_{k,1}$ is the leading variable action.

Additionally, for unprotected footbridges (as this is the case) the traffic load is not considered together with wind or snow load. Also the concentrated traffic load should not be considered together with other variable loads.

According to the requirements stated above, we can construct a number of combinations of actions, taking in turn each variable load as a leading variable action. These combinations are the following:

- I, leading action S: $1,35 \cdot G + 1,5 \cdot S + 0 \cdot W + 0 \cdot T + 0 \cdot q + 0 \cdot Q$
- II, leading action W: $1,35 \cdot G + 1,5 \cdot W + 0 \cdot S + 0 \cdot T + 0 \cdot q + 0 \cdot Q$
- III, leading action T: $1,35 \cdot G + 1,5 \cdot T + 0 \cdot W + 0 \cdot S + 1,35 \cdot 0,4 \cdot q + 0 \cdot Q$
- IV, leading action q: $1,35 \cdot G + 1,35 \cdot q + 0 \cdot W + 0 \cdot T + 0 \cdot S + 0 \cdot Q$
- V, leading action Q: $1,35 \cdot G + 1,35 \cdot Q + 0 \cdot W + 0,5 \cdot T + 0 \cdot q + 0 \cdot S$

In the case of accidental combination of actions, we have the following equation (equation (6.11b) of the Eurocode EN 1990 [1]):

$$\sum_{j \geq 1} G_{k,j} + A_d + \psi_{1,i} Q_{k,1} + \sum_{i > 1} \psi_{2,i} Q_{k,i} \quad (21)$$

where A_d is the design value of accidental action and $\psi_{1,i}$ (0,4 for traffic load, 0,5 for wind load, 0,6 for temperature effect and 0 for other variable actions) and $\psi_{2,i}$ (0,5 for temperature effect and 0 for other variable actions) are the combination factors for the accidental situation.

Again, $Q_{k,1}$ is the leading variable action. Wind and snow are not considered with accidental actions. So we have the following combinations:

- I, leading action T: $G + Q_A + 0,6 \cdot T + 0 \cdot q + 0 \cdot Q$
 II, leading action q: $G + Q_A + 0,4 \cdot q + 0,5 \cdot T + 0 \cdot Q$
 III, leading action Q: $G + Q_A + 0 \cdot Q + 0,5 \cdot T + 0 \cdot q$

4.2 Combination of actions for the serviceability limit state verification

The verification of the serviceability limit state is carried out with the combination of actions following the equation 6.15b of the Eurocode EN 1990 [1]:

$$\sum_{j \geq 1} G_{k,j} + \psi_{1,i} Q_{k,1} + \sum_{i > 1} \psi_{2,i} Q_{k,i} \quad (22)$$

The same rules considering the simultaneity of variable actions as for the fundamental combinations of actions apply also in this case. The combination factors $\psi_{1,i}$ and $\psi_{2,i}$ are the same as above. We have the following combinations:

- I, leading action S: $G + 0,5 \cdot S + 0 \cdot W + 0,5 \cdot T + 0 \cdot q + 0 \cdot Q$
 II, leading action W: $G + 0,5 \cdot W + 0 \cdot S + 0 \cdot T + 0 \cdot q + 0 \cdot Q$
 III, leading action T: $G + 0,6 \cdot T + 0 \cdot W + 0,2 \cdot S + 0 \cdot q + 0 \cdot Q$
 IV, leading action q: $G + 0,4 \cdot q + 0 \cdot W + 0,5 \cdot T + 0 \cdot S + 0 \cdot Q$
 V, leading action Q: $G + 0,5 \cdot Q + 0 \cdot W + 0,5 \cdot T + 0 \cdot q + 0 \cdot S$

5 REFERENCES

- [1] EN 1990 Eurocode - Basis of structural design.
 [2] EN 1991-1-1 Eurocode 1: Actions on structures. Part 1-1: General actions - Densities, self-weight, imposed loads for buildings.
 [3] EN 1991-1-3 Eurocode 1: Action on structures – Part 1-1: General actions – Snow loads.
 [4] EN 1991-1-4 Eurocode 1: Action on structures – Part 1-1: General actions – Wind loads.
 [5] EN 1991-2. Eurocode 1: Action on structures – Traffic loads on bridges.
 [6] EN 1993-1-1 Eurocode 3: Design of steel structures – Part 1-1: General rules and rules for buildings.
 [7] JCSS: *Probabilistic model code*. JCSS working materials, <http://www.jcss.ethz.ch/>, 2001.

CHAPTER 6: EXAMPLE OF A COMPOSITE BRIDGE

Oliver Kraus¹, Christiane Butz¹

¹Institute of Steel Construction, RWTH Aachen, Germany

1 INTRODUCTION

A composite bridge which forms a simple beam after the erection stage is verified according to the Eurocodes. Load assumptions are applied corresponding to EN 1991-2 [2] and EN 1991-1-4 [3]. This example does not represent a complete verification of the bridge structure but has got the purpose to clarify which loads are relevant and how the internal forces are determined in case of a composite bridge.

2 DEFINITION OF THE SYSTEM

2.1 Details of the System

The composite bridge over a street investigated here consists of a concrete slab and two welded steel girders. For determination of the wind loads the following parameters are given: The distance between surface of the street and lower flange of the steel girders is 4,5 m and the bridge is located in flat open terrain.

It shall be verified whether the bending resistance of the section fulfills the requirements of the Ultimate Limit State of the Eurocodes and whether the deflections of the bridge deck are within the limits of the Serviceability Limit State. Furthermore the frame structure which consists of stiffeners and transversal girders shall be verified for the Ultimate Limit State

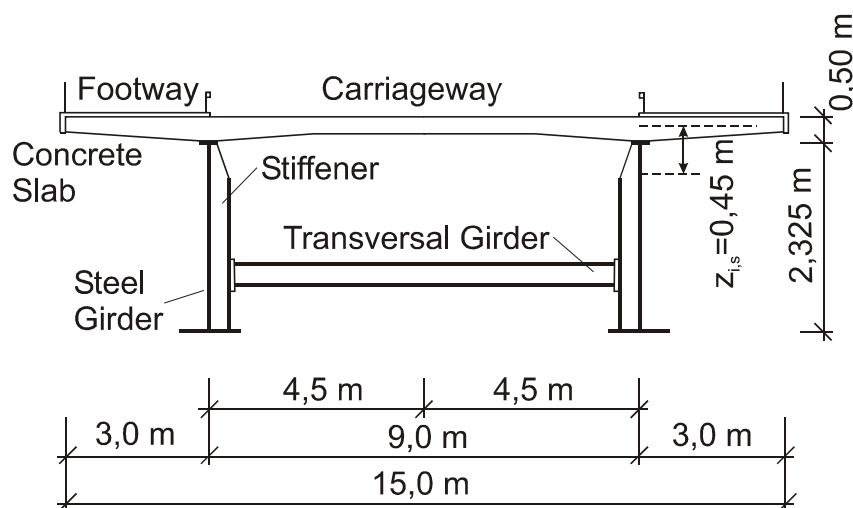


Figure 1. Composite section of the bridge

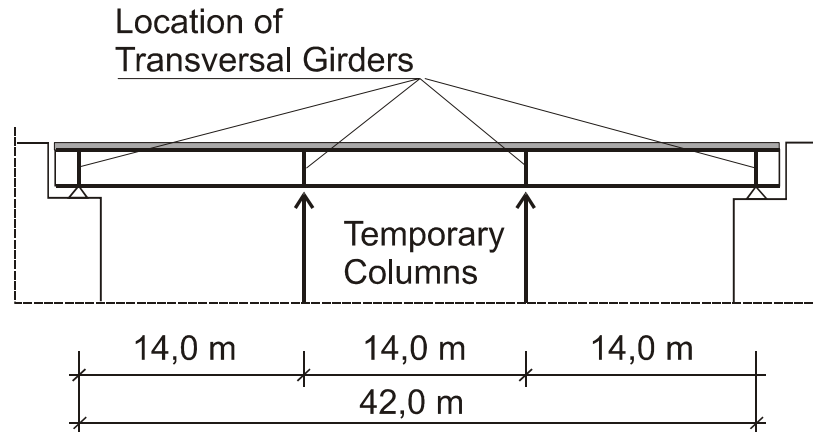


Figure 2. Static system of the bridge

2.2 Load History

The load which is carried by the structural steel and the load which is carried by the composite section has to be known in order to determine the deflection of the structure which is a decisive parameter for the verification in the Serviceability Limit State.

Supporting the steel beam before pouring the concrete and detaching these supports after hardening of the concrete slab will lead to the effect that both, the self weight of the steel as well as the self weight of the concrete, is carried by the composite section. In contrast to that an erection of a simple beam without temporary supports means that the self weight is carried by the steel beam only. It has to be noted that the load history does not affect the ultimate resistance of the structure but the stress distribution and the deflection.

In case of the example presented here the following erection method is assumed:

1. The steel beam is put on the permanent abutments forming a simple beam.
2. Two temporary columns are attached and prestressed leading to a continuous beam which carries the self weight of the structural steel.
3. The concrete of the carriageway is poured.
4. The temporary columns and the form boards are removed after hardening of the concrete slab.
5. After applying additional loads (for the roadbed etc.) the bridge is prepared to carry traffic loads and further variable actions.

Hence for the verification of the construction stage the following loads have to be considered:

1. The steel girder as simple beam carrying its self-weight and wind loads.
2. The steel girder as a continuous beam carrying its self-weight, the prestressing force and wind loads.
3. The steel girder as a continuous beam carrying its self-weight, the prestressing force, the weight of the fresh concrete and wind loads.
4. The steel girder as a continuous beam carrying its self-weight, the prestressing force, the weight of the hardened concrete and wind loads.

In the final stage the composite structure has to be checked as a simple beam carrying its self-weight, imposed loads, traffic loads and wind loads

In this example the check for the final stage and the check for the construction stage when the girder is prestressed by temporary columns and the concrete is already cured.

2.3 Properties of the Section

2.3.1 Bending Capacities

In order to carry out the verification for the construction stage the design value of the bending capacity of the steel girder has to be known:

$$M_{el,a,Rd} = 32\,346 \text{ kNm}$$

The design value of the plastic bending capacity of the composite section (neutral axis in the concrete slab) is:

$$M_{pl,Rd} = 60\,000 \text{ kNm}$$

2.3.2 Moments of Inertia

The moments of inertia are needed for the calculation of the deflections as a criterion for the verification in the Serviceability Limit State. For the calculation the time-dependency of the sectional properties because of creeping have to be taken into account. This leads to a distinction between the corresponding values for moments of inertia:

Definition of action	Moment of inertia [mm ⁴]	Moment of inertia [cm ⁴]
short duration action effect	$3,040758 \cdot 10^{11}$	30 407 580
long duration action effect	$2,5323208 \cdot 10^{11}$	25 323 208
shrinkage	$2,7573969 \cdot 10^{11}$	27 573 969

Table 1. Moments of inertia for the composite section

2.4 Resistance of the Transversal Girder and of the Stiffeners

For the transversal girder a rolled steel profile HE 200 A with steel grade S 355 is used. Then the following design values of the resistance are given:

$$M\text{-}N\text{-interaction about strong axis: } N_{Rd} = \chi_y \cdot N_{pl,Rd} = 710 \text{ kN} \quad M_{pl,y,Rd} = 152,7 \text{ kNm}$$

$$\text{buckling about weak axis: } N_{Rd} = \chi_z \cdot N_{pl,Rd} = 649 \text{ kN}$$

The stiffener consists of one half of a profile HE 360 B with steel grade S 355. In combination with the relevant part of the web of the main girder the following design values for the resistance are obtained:

$$N_{pl,Rd} = 5491,85 \text{ kN}$$

$$M_{pl,Rd} = 400 \text{ kN}$$

3 DEFINITION OF LOADS

3.1.1 Permanent Loads Acting on the Structural Steel

Self weight of one welded steel profile ($\gamma_a = 78,5 \text{ kN/m}^3$):

$$g_a = 7,0 \text{ kN/m}$$

Self weight of the concrete slab ($\gamma_c = 25 \text{ kN/m}^3$):

$$\text{Sectional area: } A_c = 2 \cdot \left[7,5 \cdot 0,5 - \frac{1}{2} \cdot (2,8 + 2,0) \cdot 0,2 - 2,3 \cdot 0,2 \right] = 5,62 \text{ m}^2$$

$$g_c = 5,62 \cdot 25 = 140,50 \text{ kN/m}$$

Self weight of the fresh concrete ($\gamma_c = 26 \text{ kN/m}^3$):

$$Q_{cf} = 5,62 \cdot 26 = 146,12 \text{ kN/m}$$

Prestressing applied on each temporary column:

$$P_v = 1280 \text{ kN}$$

3.1.2 Permanent Loads Acting on the Composite Beam

Self weight of cap, handrails, safety fence and asphalt of one half of the bridge deck:

$$g_{add} = 30 \text{ kN/m}$$

3.2 Traffic Loads

According to EN 1991-2 the width w of the carriageway is defined by the inner limits of vehicle restraint systems as safety fences, kerbs etc. The width of the carriageway used for calculation includes all areas which could be used by vehicles as e.g. hard shoulders.

The carriageway has to be divided into several notional lanes. EN 1991-2 gives the following equation for calculation of the number of notional lanes in case of a width w which is equal or greater than 6,0 m:

$$n_l = \text{Int}\left(\frac{w}{3}\right) = \text{Int}\left(\frac{9}{3}\right) = 3$$

Consequently the width w_l of each notional lane is:

$$w_l = 3,0 \text{ m}$$

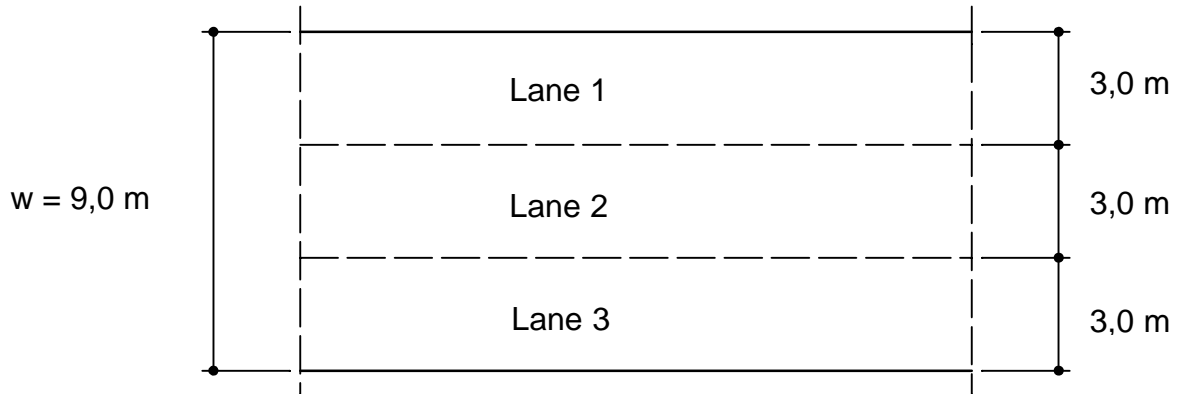


Figure 3. Width of notional lanes

Four different load models are given in EN 1991-2 of which only Load Model 1 (LM1) for the general verification is relevant here. The further models define specific design situations for local verifications, abnormal loads and crowd loads which can be neglected in case of the given example.

Load Model 1 consists of concentrated loads Q_k represented by a tandem system with two axles as well as of uniformly distributed loads q_k . In these loads a dynamic amplification is taken into account. Both loadings have to be applied in the most unfavourable way, i.e. the loads should be neglected where they result into favourable effects.

In case of three notional lanes the loads as defined in table 2 are given:

	tandem load	distributed load
Lane 1	300 kN	9,0 kN/m ²
Lane 2	200 kN	2,5 kN/m ²
Lane 3	100 kN	2,5 kN/m ²

Table 2. Traffic loads in case of three notional lanes

The spacing between axles transverse to the longitudinal axis of the bridge is assumed as 2,00 m and the tandem loads have to be positioned in the middle of each lane.

In order to take into account the expected traffic two adjustment factors α_Q and α_q are applied to the concentrated loads and to the uniformly distributed loads. These values should be applied according to the relevant National Annex or in accordance with the following general recommendation for bridges without traffic signs limiting the maximum weight of vehicles:

first lane: $\alpha_{Q1} = 0,8$

further lanes: $\alpha_{Qi>1} = 1,0$

With these input parameters the following actions are obtained:

$$\begin{aligned} \text{first lane:} \quad Q_{1k} &= 0,8 \cdot 300 = 240 \text{ kN} & q_{1k} &= 0,8 \cdot 9,0 = 7,2 \text{ kN/m}^2 \\ \text{second lane:} \quad Q_{2k} &= 1,0 \cdot 200 = 200 \text{ kN} & q_{2k} &= 1,0 \cdot 2,5 = 2,5 \text{ kN/m}^2 \\ \text{third lane:} \quad Q_{3k} &= 1,0 \cdot 200 = 200 \text{ kN} & q_{3k} &= 1,0 \cdot 2,5 = 2,5 \text{ kN/m}^2 \end{aligned}$$

Since one tandem load consists of two axles each of the four wheels corresponds to a load of $0,5 Q_k$. Due to the fact that a distance between both axles of one tandem system in longitudinal direction of the bridge is not important for a general structural analysis here as a simplification the tandem system is applied as one axis with two wheels each representing a concentrated load of Q_k :

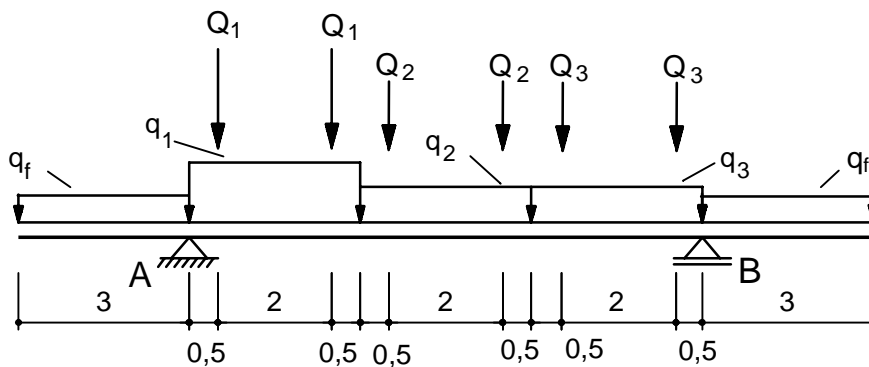


Figure 4. Traffic loads on the bridge

3.3 Actions on Footways

The loading due to pedestrians is represented by a uniformly distributed load q_{fk} depending on the length L of the footway. EN 1991-2 gives the following formulation for the action on footways:

$$2,5 \text{ kN/m}^2 \leq 2,0 + \frac{120}{L + 30} \leq 5,0 \text{ kN/m}^2$$

Consequently in the example with $L = 42 \text{ m}$ a characteristic value of

$$q_{fk} = 3,67 \text{ kN/m}^2$$

has to be taken into account for the load on footways. In case the load on footways has to be taken into account simultaneously with the load on the carriageway a combination value of q_{fk} has to be chosen. In EN 1991-2 a combination value

$$q_{fk} = 3,00 \text{ kN/m}^2$$

is recommended.

3.4 Wind Loads

3.4.1 Determination of the Relevant Gust Wind Pressure

The basic wind velocity is given as

$$v_b = 25 \text{ m/s}$$

In chapter 1 it is mentioned that the surroundings are open terrain without hills and other obstacles and that the clearance between street and bridge is 4,5 m. With these input parameters the exposure factor for transforming the mean pressure corresponding to v_b into a gust pressure in the relevant height above ground level can be determined:

$$c_e(z) = c_r^2(z) \cdot c_o^2(z) \cdot [1 + 7 \cdot I_v(z)]$$

where: $c_r(z) = k_r \cdot \ln\left(\frac{z}{z_0}\right)$ logarithmic velocity profile

k_r terrain factor

z_0 roughness length

$c_o(z)$ orography factor (takes into account isolated changes in the terrain height) – here: $c_o(z) = 1,0$

$I_v(z) = \frac{1}{c_o(z) \cdot \ln(z/z_0)}$ turbulence

Since open flat surroundings with isolated trees according to prEN 1991-1-4 means terrain category II here $k_r = 0,19$ and $z_0 = 0,05$ m have to be introduced in the above mentioned equations. The reference height for bridge decks is the center of the bridge construction without additional elements as parapets etc. leading to a value of :

$$z = 4,5 + \frac{1}{2} \cdot (2,325 + 0,5) = 5,9 \text{ m}$$

The resulting exposure factor is:

$$c_e(5,9) = \left[0,19 \cdot \ln\left(\frac{5,9}{0,05}\right) \right]^2 \cdot 1,0 \cdot \left[1 + 7 \cdot \frac{1}{1,0 \cdot \ln(5,9/0,05)} \right] = 2,03$$

Consequently we get the following gust wind pressure in reference height:

$$q_p(z_e) = c_e(z_e) \cdot \frac{\rho}{2} \cdot v_b^2 = 2,03 \cdot \frac{1,25}{2} \cdot 25^2 = 793 \text{ N/m} \hat{=} 0,79 \text{ kN/m}^2$$

3.4.2 Horizontal Wind Forces

In prEN 1991-1-4 force coefficients for horizontal forces transversal to the bridge deck c_{fx} as well as in longitudinal direction of the bridge c_{fy} are given. Here it is assumed that

effects due to horizontal forces in longitudinal direction can be neglected. The horizontal force induced by wind action is formulated as:

$$F_{w,x} = q_p(z) \cdot c_{fx} \cdot A_{ref,x}$$

Force coefficients c_{fx} are given in dependence on the relation between height of the bridge deck d and width of the bridge deck b . Here we get the value

$$\frac{d}{b} = \frac{15,0}{2,825} = 5,31$$

for which prEN 1991-1-4 recommends a force coefficient of

$$c_{fx} = 1,3$$

The reference area $A_{ref,x}$ for the relevant shape of bridge decks is defined as the sum of the face area of the windward girder and the face area of the slab. This value could be relevant for an erection state. For the final state it has to be decided whether the area of parapets have to be taken into account (e.g. the height 0,3 m is recommended for open parapets) or if an additional area has to be introduced due to the expected traffic which height should be assumed as 2,0 m above the surface of the carriageway. Here the second option, i.e. the additional height of 2,0 m is assumed to be relevant. These assumptions lead to a reference area of:

$$A_{ref,x} = (2,825 + 2,0) \cdot L = 4,825 \cdot L$$

The horizontal wind force can be formulated as an uniformly distributed load

$$F_{wx} = 0,79 \cdot 1,3 \cdot 4,825 = 4,96 \text{ kN/m}$$

The horizontal wind force is relevant for the verification of the transversal girder between the main steel girders.

3.4.3 Vertical Wind Forces

A force coefficient

$$c_{fz} = \pm 0,9$$

is given in prEN 1991-1-4 for cases where no results of wind tunnel measurements are available. The relevant reference Area $A_{ref,z}$ corresponds to the vertical projection of the bridge deck:

$$A_{ref,y} = 15,0 \cdot L$$

These input data give the following uniformly distributed vertical load on the bridge deck:

$$F_{w,y} = \pm 0,79 \cdot 0,9 \cdot 15,0 = \pm 10,7 \text{ kN/m}$$

This load should be applied with an excentricity of

$$e = \frac{b}{4} = 3,75 \text{ m}$$

3.5 Thermal Actions

Here the temperature difference $\Delta T = \pm 15 \text{ K}$ is applied. The thermal factor for the composite section is $\alpha_T = 1,2 \cdot 10^{-5} \text{ K}^{-1}$.

3.6 Effects due to Shrinkage

The axial force due to shrinkage acting on the concrete slab which is needed to determine the bending moment due to shrinkage is given as:

$$N = 15523,4 \text{ kN}$$

3.7 Temporary Loads during Construction

The loads due to form boards construction equipment etc. is applied as a uniformly distributed load acting over the whole length of the bridge:

$$p_{temp} = 10,0 \text{ kNm}$$

4 CALCULATION OF INTERNAL FORCES

4.1 Distributions of Characteristic Loads on the Bridge Deck

In order to simplify the calculation the bridge deck is divided into two halves at the vertical center line of the section. Then the analysis is carried out for that half with the more unfavourable loading. Due to that in a first step the loads have to be transformed into loads acting on one steel girder. In figure 5 the loads on the carriageway are given together with the influence line for one steel girder schematised as a support.

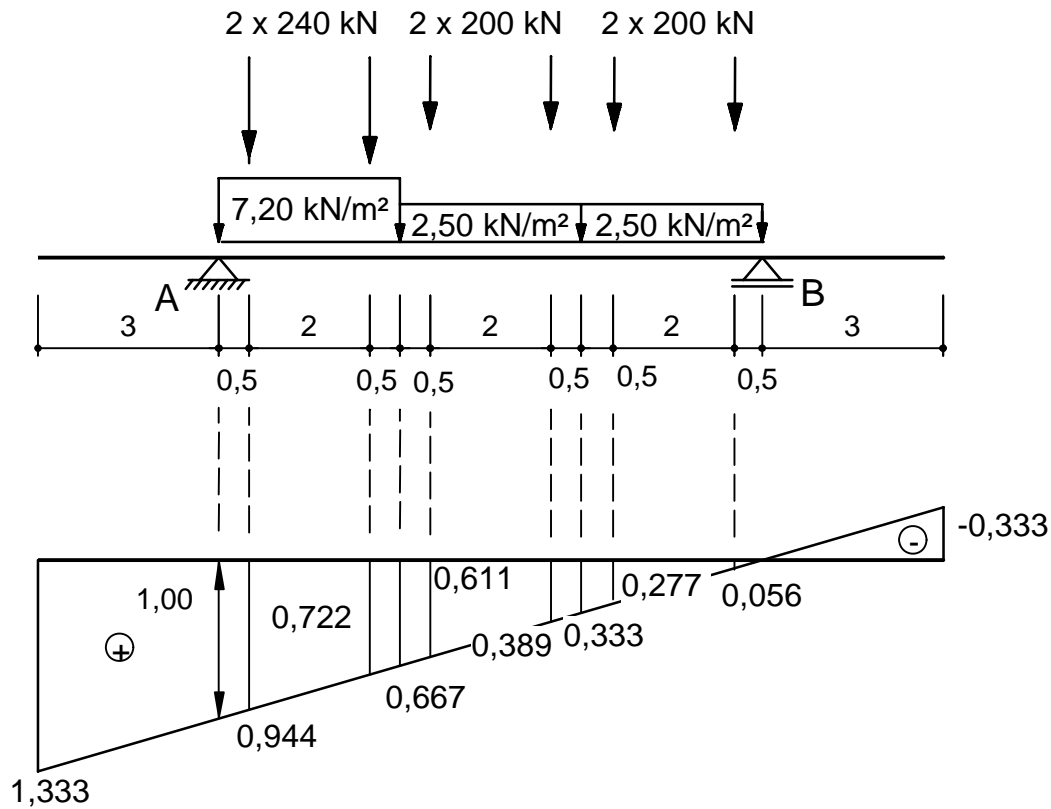


Figure 5. Characteristic values of traffic loads on the bridge deck and influence line for girder A

Then the following concentrated and uniformly distributed loads are obtained for one half of the bridge deck:

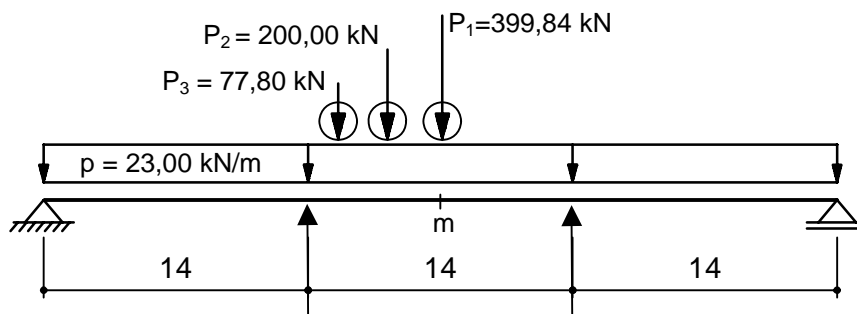


Figure 6. Characteristic values of traffic loads acting on one half of the bridge

For loads on the footway EN 1991-2 recommends a characteristic value of $3,67 \text{ kN/m}^2$ and a combination value of $3,00 \text{ kN/m}^2$ in case it has to be taken into account simultaneously with traffic loads. Using the influence line given in figure 5 and applying the action only where unfavourable the following uniformly distributed load is obtained:

characteristic value: $p_{\text{foot}} = 12,85 \text{ kN/m}$
 combination value: $p_{\text{foot}} = 10,50 \text{ kN/m}$

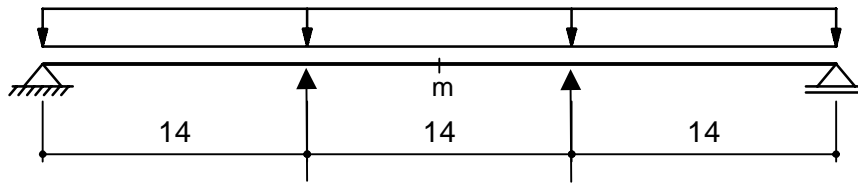


Figure 7. Characteristic value and combination value of the load on the footway

The same procedure has to be carried out for the vertical wind force. Assuming that the excentricity of that force is 3,75 m, as recommended in EN 1991-2, results into the following loading on one girder:

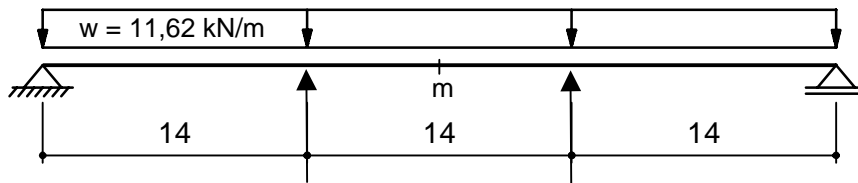


Figure 8. Characteristic value of the vertical wind load

4.2 Bending Moments in the Construction Stage (Continuous Beam)

During construction the static system corresponds to a continuous beam due to the temporary columns. In this stage the self weight of the steel girders and of the concrete slab is relevant. Please note that for the verification of the structure in the construction stage also additional loads due to construction equipment and vertical wind loads are relevant.

4.2.1 Moments due to permanent loads during erection

With the characteristic loads for one half of the beam the following moment distribution is obtained:

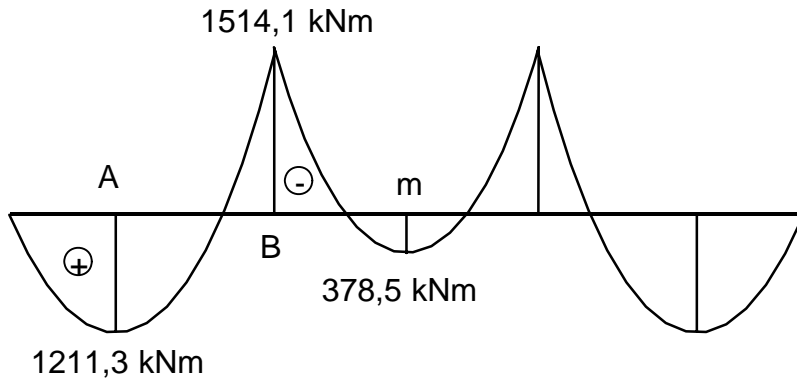


Figure 9. Moment distribution due to the characteristic value of self weight

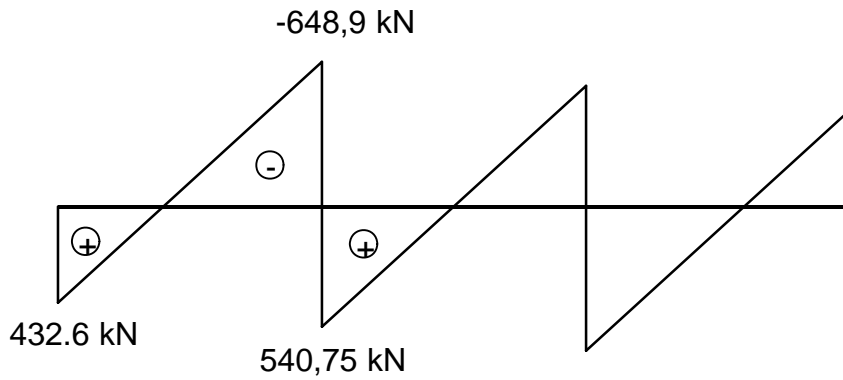


Figure 10. Shear force distribution due to the characteristic value of self weight

The moment distribution due to the prestressing of the columns is:

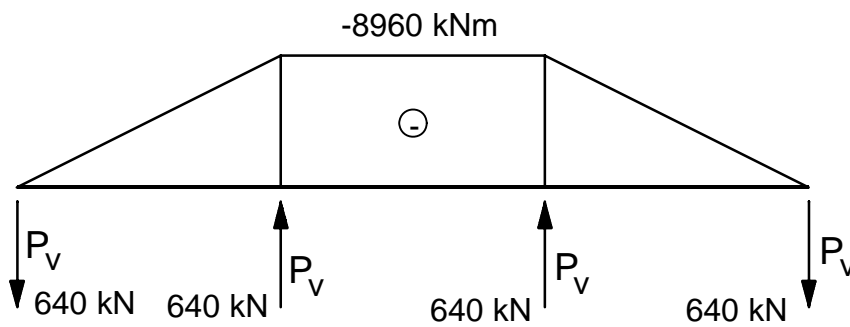


Figure 11. Moment distribution due to prestressing of the temporary columns

4.2.2 Moments due to Temporary Loads during Erection

The uniformly distributed load for construction equipment on one half of the bridge section is 5,0 kN/m resulting into:

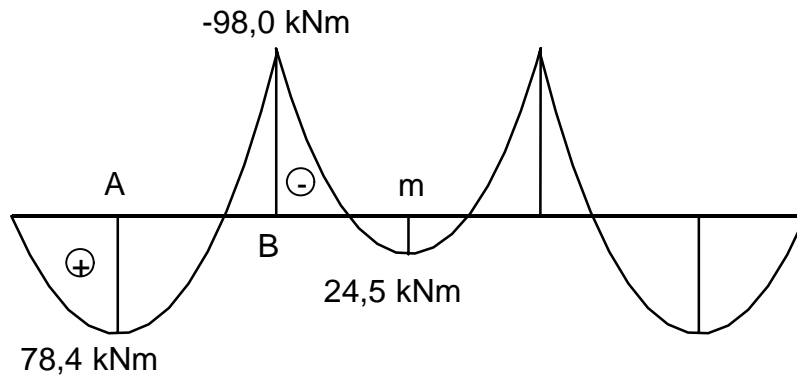


Figure 12. Moment distribution due to temporary loads in the construction stage

4.2.3 Moments due to Vertical Wind Loads during Erection

The vertical wind load is relevant for the verification in the erection state:

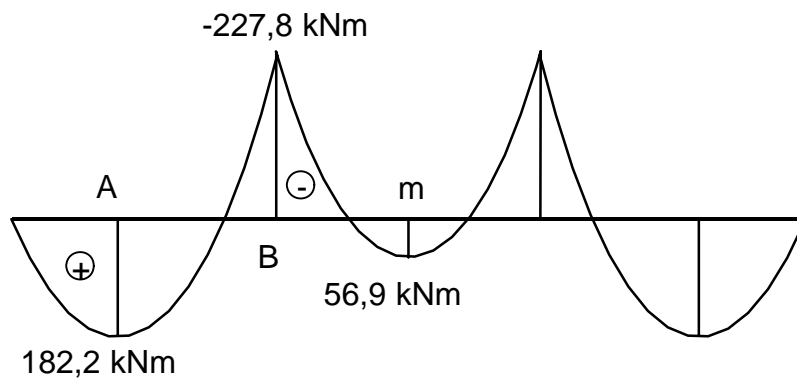


Figure 13. Moment distribution due to vertical wind loads in the construction stage

4.3 Bending Moments in the Final Stage

4.3.1 Moments due to Permanent Loads

Since the temporary columns are replaced after hardening of the concrete slab also the corresponding column forces have to be applied besides the additional permanent loads due to handrails, caps etc. and traffic loads.

The moment distribution due to these actions is determined by applying the forces of the temporary columns together with the prestressing forces on the bridge deck. Consequently for each temporary column the resulting characteristic value of the force consists of 1189,65 kN for the support reaction (see figure 10) plus 640 kN for the prestressing.

Applying the additional permanent load simultaneously with the above mentioned forces for the temporary columns the following loading is obtained:

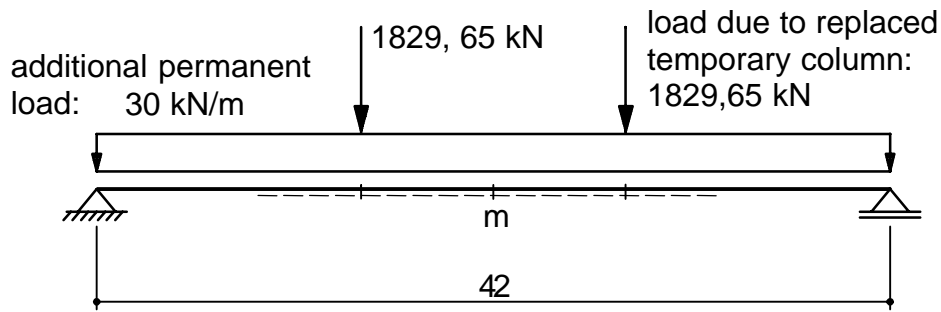


Figure 14. Permanent loads acting on the composite beam

The permanent loads result into the following distribution of the bending moment:

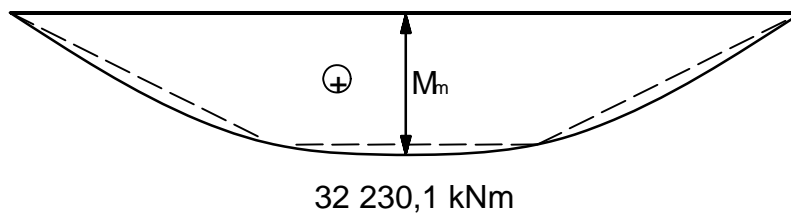


Figure 15. Bending moment due to the characteristic values of permanent loads

4.3.2 Moments due to Traffic Loads

Placing all concentrated traffic loads in the middle of the composite beam results into the most unfavourable load situation, i.e. into the maximum bending moment:

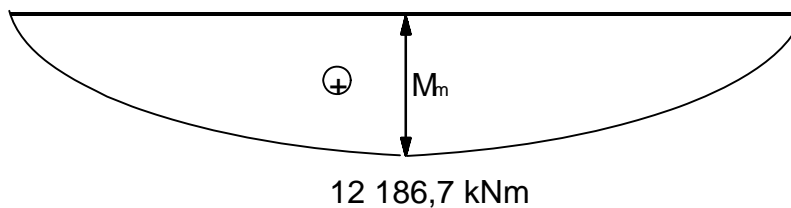


Figure 18. Bending moment due to the characteristic value of traffic loads

4.3.3 Moments due to Loads on the Footway

For the characteristic value and for the combination value the following bending moment is determined:

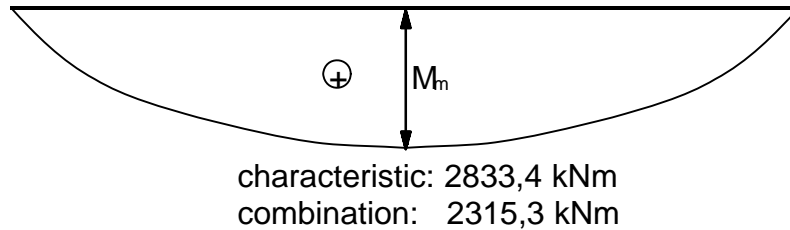


Figure 19. Bending moment due to the characteristic value of traffic loads

4.3.4 Moments due to Vertical Wind Forces

Only vertical wind loads acting downwards have an unfavourable effect in combination with the further loads:

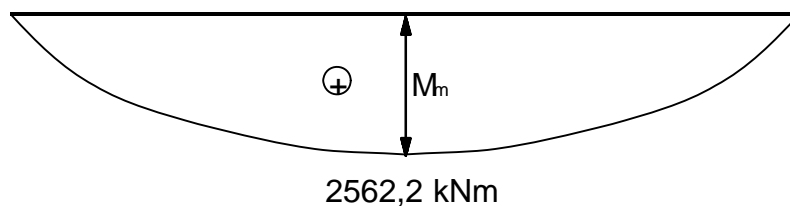


Figure 20. Bending moment due to the characteristic value of vertical wind forces

4.4 Internal Forces Acting on the Transversal Girder and the Stiffeners

The transversal girder forms a frame system which carries the horizontal wind loads. These frames are placed at the abutments as well as at the location of the temporary columns. The following static system and loading is given for the inner frames which are relevant for verification since they are affected by the most unfavourable load:

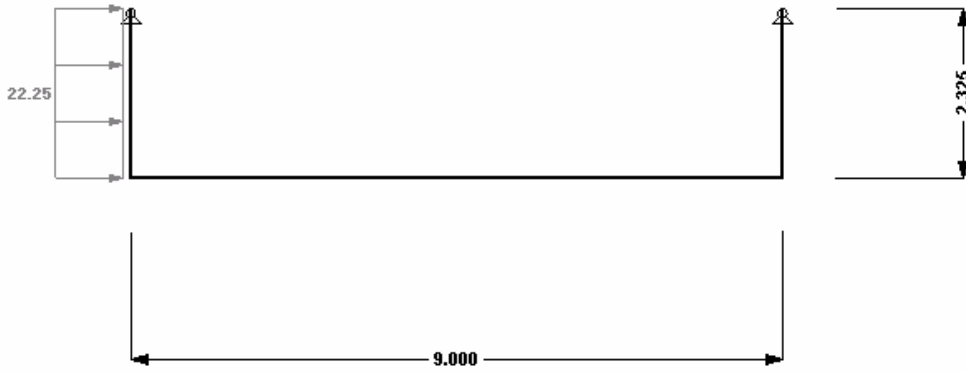


Figure 21. Wind Load [kN/m] on the frame

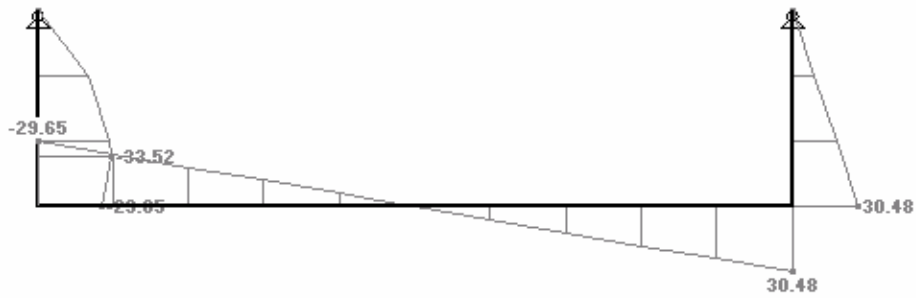


Figure 22. Moment distribution [kNm] at the frame structure

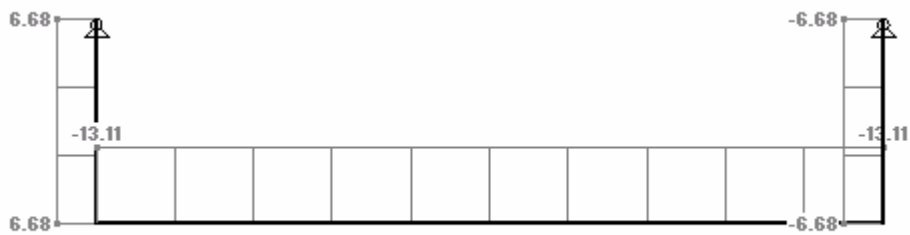


Figure 23. Distribution of axial forces [kN] in the frame structure

4.5 Summary of the Relevant Internal Forces

4.5.1 Bending Moments in the Bridge Girder

In the following table a summary of the relevant bending moments in the beam is given:

Load	construction stage			final stage
	location A	location B	location m	location m
self weight of bridge	1 211,3 kNm	-1 514,1 kNm	378,5 kNm	378,5 kNm
prestressing	-480,0 kNm	-8 960,0 kNm	-8 960,0 kNm	-8 960,0 kNm
temporary loads (constr.)	78,4 kNm	-98,0 kNm	24,5 kNm	
vertical wind (erection)	182,2 kNm	-227,8 kNm	56,9 kNm	
vertical wind (final)				2 562,2 kNm
additional loads*				32 230,1 kNm
traffic loads				12 186,7 kNm
loads on footway (char.)				2 833,4 kNm
loads on footway (comb.)				2 315,3 kNm

*due to additional elements and after replacing columns

Table 3. Bending moments for one half of the bridge girder

4.5.2 Internal Forces in the Transversal Girder and the Stiffeners

The maximum bending moment in the frame structure is:

$$M = 30,48 \text{ kNm}$$

The axial force in the transversal girder is:

$$N = -13,11 \text{ kN}$$

5 VERIFICATIONS

5.1 Verification for the Ultimate Limit State

5.1.1 General

Here the verification for the Ultimate Limit State shall be carried out by using equation 6.10 of EN 1990:

$$\sum_{j \geq 1} \gamma_{G,j} G_{k,j} + \gamma_P P + \sum_{i > 1} \gamma_{Q,i} Q_{k,i} + \sum_{i > 1} \gamma_{Q,i} \psi_{0,i} Q_{k,i}$$

where: G permanent loads
 P prestressing

Q_k	characteristic value of variable action
γ_G	partial factor for permanent load; 1,35 (unfavourable) or 1,0 (favourable)
γ_P	partial factor for prestressing; here: 1,1 (unfavourable) or 1,0 (favourable)
γ_Q	partial factor for variable actions; 1,5 (unfavourable) or 0,0 (favourable)
ψ_0	combination factor; for wind: 0,6

The partial factors and combination factors can be applied on the action effects (e.g. bending moments).

5.1.2 Verification of the Steel Girder in the Erection Stage

It has to be checked whether the resistance of the welded steel profile is sufficient to carry the loads during the construction stage. Introducing the bending moments given in table 3 together with the relevant partial factors gives the following design values of bending moments:

Location A:

$$M_{Ed} = 1,35 \cdot 1211,3 - 1,0 \cdot 480,0 + 1,35 \cdot 78,4 + 1,5 \cdot 182,2 = 1534,4 \text{ kNm} < M_{Rd} = 32346 \text{ kNm}$$

Location B:

$$\begin{aligned} M_{Ed} &= -1,35 \cdot 1514,1 - 1,1 \cdot 8960,0 - 1,35 \cdot 98,0 - 1,5 \cdot 227,8 \\ &= -12374,0 \text{ kNm} < -M_{Rd} = -32346 \text{ kNm} \end{aligned}$$

Location m:

$$\begin{aligned} M_{Ed} &= 1,0 \cdot 378,5 - 1,1 \cdot 8960,0 + 1,0 \cdot 24,5 + 0,0 \cdot 56,9 \\ &= -9453,0 \text{ kNm} < -M_{Rd} = -32346 \text{ kNm} \end{aligned}$$

Here the design values of all actions during construction are much lower than the resistance of the steel girders. It has to be noted that according to prEN 1991-1-4 it is allowed to reduce the wind loads in case of temporary design situations. On the safe side this reduction is not applied here.

5.1.3 Verification of the Composite Beam in the Final Stage

Since in the final stage the system corresponds to a simple beam with constant cross section the middle of the span is the only relevant location for a verification. The additional permanent loads after replacing the temporary columns represent the dominating action:

$$\begin{aligned} M_{Ed} &= 1,35 \cdot 378,5 - 1,0 \cdot 8960,0 + 0,6 \cdot 1,5 \cdot 2562,2 + 1,35 \cdot 32230,1 + 1,50 \cdot 12186,7 \\ &\quad + 1,50 \cdot 2315,3 = 59120 \text{ kNm} < M_{pl,Rd} = 60000 \text{ kNm} \end{aligned}$$

5.1.4 Verification of the Transversal Girder and of the Stiffener

The verification has to be carried out for the M - N -interaction about the strong axis as well as for buckling about the weak axis.

$$\text{strong axis: } \frac{N_{Ed}}{\chi_y \cdot N_{pl,Rd}} + \frac{k_y \cdot M_{Ed}}{M_{pl,y,Rd}} = \frac{13,11}{1909,6} + \frac{1,122 \cdot 30,48}{152,7} = 0,23 < 1,0$$

where: k_y factor for distribution of bending moment

$$\text{weak axis: } N_{Ed} = 13,11 \text{ kN} < \chi_z \cdot N_{pl,Rd} = 649,3 \text{ kN}$$

5.2 Verification for the Serviceability Limit State

It shall be checked whether the maximum deflection w , i.e. the deflection in the middle of the span, corresponds to a value greater than $L/w = 250$.

The verification shall be carried out using equation 6.15b of EN 1990 for frequent design situations, which is recommended in particular in case of reversible effects and which is also recommended in EN 1991-2 for a verification using Load Model 1:

$$\sum_{j \geq 1} G_{k,j} + P + \psi_{1,i} Q_{k,i} + \sum_{i > 1} \psi_{2,i} Q_{k,i}$$

where: ψ_1 combination factor for frequent design situations;
 here: 0,5 for traffic loads; 0,2 for wind loads; 0,5 for temperature effects
 ψ_2 combination factor for quasi-permanent design situations
 here: 0,3 for traffic loads; 0,0 for wind loads; 0,0 for temperature effects

- Deflection due to the permanent loads and replaced temporary columns:
 The deflection in the middle of the simple beam with two concentrated loads is

$$w = 0,0355 \cdot \frac{P \cdot L^3}{EI} = 0,0355 \cdot \frac{1829,7 \cdot 42000^3}{210 \cdot 2,5323208 \cdot 10^{11}} = 90,5 \text{ mm}$$

- Deflection due to additional permanent loads after replacing temporary columns:
 The deflection in the middle of the simple beam is

$$w = \frac{5}{384} \cdot \frac{g_{add} \cdot L^4}{EI} = \frac{5}{384} \cdot \frac{0,30 \cdot 42000^4}{210 \cdot 2,5323208 \cdot 10^{11}} = 22,9 \text{ mm}$$

- Deflection due to traffic loads:

$$w = \frac{5}{384} \cdot \frac{p \cdot L^4}{EI} = \frac{5}{384} \cdot \frac{0,23 \cdot 42000^4}{210 \cdot 3,0407580 \cdot 10^{11}} = 14,6 \text{ mm}$$

- Deflection due to temperature effects:

Then the thermal coefficient for a structure which consists of steel and concrete elements can be assumed as

$$a_T = 1,2 \cdot 10^{-5} \text{ K}^{-1}$$

The deflection in the middle of the simple beam is

$$w = \frac{\alpha_T \cdot 10^{-5} \cdot \Delta T \cdot L^2}{8} = \frac{1,2 \cdot 10^{-5} \cdot 15 \cdot 42000^2}{8} = 14,05 \text{ mm}$$

- Deflection due to creeping:

The creeping moment is determined by applying the axial force which is caused by creeping on the concrete slab. With the distance between the neutral axis of the slab and of the composite section $z_{i,s} = 0,45 \text{ m}$ (see figure 1) the following bending moment is obtained:

$$M = 15523,4 \cdot 0,45 = 6985,5 \text{ kNm}$$

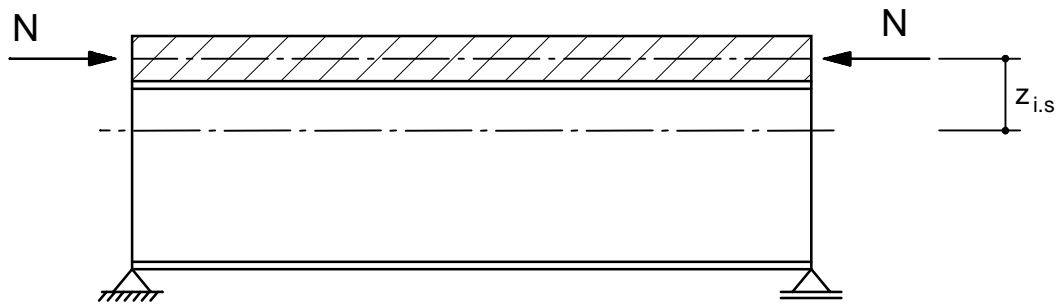


Figure 24. Axial force caused by creeping of the concrete slab

The deflection for a simple beam affected by a constant bending moment is:

$$w = \frac{M \cdot L^2}{8 \cdot EI} = \frac{6985,5 \cdot 10^3 \cdot 42000^2}{8 \cdot 210 \cdot 2,7573696 \cdot 10^{11}} = 26,6 \text{ mm}$$

The deflection due to vertical wind is neglected because the quasi-permanent combination factor for this non-dominating action is $\psi_2 = 0,0$.

According to EN 1991-2 the loads on the footway are not taken into account for the verification in the Serviceability Limit State.

Applying equation 6.15b the following resulting maximum deflection is obtained:

$$w_{res} = 90,5 + 22,9 + 0,3 \cdot 14,6 + 26,6 = 144,4 \text{ mm}$$

This corresponds to $\frac{L}{w} = \frac{42000}{144,4} = 291 > 250$

6 REFERENCES

[1] EN 1990, “Basis of design”

[2] EN 1991-2, “Actions on structures – Traffic loads on bridges”

[3] EN 1991-1-4, “Actions on structures – General actions – Wind actions”

CHAPTER 7: DESIGN OF COMPOSITE BRIDGES ACCORDING TO EN 1990 AND EN 1991. CASE STUDY

Peter Tanner and Rüdiger Spengler

Institute of Construction Sciences IETcc – CSIC, Madrid, Spain

1. Introduction

1.1 Aims

The main goal of the present contribution is to study the application of the Structural Eurocodes *EN 1990 Basis of Structural Design* [EN 1990] and the different parts of *EN 1991 Actions on Structures* to the design of a composite steel and concrete road bridge. The following four aims were identified as steps towards achieving this goal:

1. Emphasize the importance of the adoption of suitable reliability measures in order to achieve the required levels of reliability relating to the resistance and the serviceability of a particular structure, in the present case a road bridge.
2. Establish the relevant design situations for the bridge taking into account the specific circumstances under which the bridge is expected to fulfil its function.
3. Define the site specific actions and environmental influences according to the models from *EN 1991 Actions on Structures*, as well as the combinations of actions to be taken into account in the relevant design situations for the verification of the structural safety and serviceability requirements.
4. For each of the relevant combinations of actions obtain the action effects to be used for the purpose of the verification of the structural safety and serviceability requirements of the considered road bridge.

1.2 Scope

The design of a road bridge would normally include the treatment of serviceability, structural safety, safety against fatigue and durability of all structural members including the bridge deck, the piers, the abutments and the foundations. However, this contribution concentrates on the aspects related with structural safety and serviceability of the bridge deck only. Furthermore, the verification of the relevant ultimate, serviceability and fatigue limit states are not explicitly covered. These verifications, that are normally carried out by the partial factor method [EN 1990], would belong to a case study concerning the application of Eurocode 4, Part 2, for the design of composite steel and concrete bridges [prEN 1994-2] and are therefore beyond the scope of the present contribution. Consequently, the example stops at the level of structural overall analysis for the determination of the relevant action effects.

Nevertheless, and although the contribution does not illustrate the aforementioned verifications, it should be mentioned that the example neither is academic nor hypothetical since it has been worked out on the basis of a real bridge design. For the purpose of the case study only some simplifications have been assumed, particularly in relation with the construction stages (Section 3.3). For this reason, all the dimensions of the bridge, the materials used and the assumptions presented hereafter are realistic and the bridge meets all the requirements of structural safety, safety against fatigue, serviceability and durability according to the relevant Structural Eurocodes.

1.3 Organisation of the contribution

The contribution starts with an introduction to describe the aims and the scope of the case study. The introduction is followed by two sections which present the boundary conditions and the conceptual design of the bridge. The success of the translation of the numerous constraints into a reliable, functional, economic and aesthetically attractive structure depends above all on a consistent conceptual design. It is at that early design stage when the decisions are to be adopted

concerning the most suitable measures to be put into practice with the objective that the bridge, with the required degree of reliability and in an economical way during the intended service period, will sustain all relevant actions and influences and will remain fit for the use for which it is planned. Section 4 is dedicated to the identification of all actions and influences likely to occur during the construction and the future use of the bridge. This is a crucial step in the whole design process since subjectively unrecognised actions or influences will not enter the further analysis and may therefore lead to a structural design with an unacceptably low reliability level. On the contrary, once the potential actions and influences have been recognised, it is usually relatively easy to adopt suitable safety measures intended to the structure achieving the required levels of reliability. Such measures are also discussed in Section 4. The specific load models for the actions entering the design calculations are mentioned in Section 5. Some particular aspects concerning the calculation of the effects of these actions on the composite bridge are discussed in Section 6. Section 7 presents the combinations of the actions corresponding to the relevant design situations. The action effects due to these combinations are to be used for the verification of structural safety and serviceability. The case study finishes in Section 8 with some general comments about the design of composite bridges according to the Structural Eurocodes.

2. Constraints

2.1 Situation

The highway bridge to be designed and built is situated in Castellón, close to the Mediterranean coast. Its location is at 50 m above the sea level and it crosses the existing highway linking Barcelona and Valencia, as well as two local roads on either side of the highway. In plan, the alignment is curved with a large radius of sharpest curve of 2500 m (Figure 1). Furthermore, it shows a strong skewing with respect to the highway and the roads to be crossed. In elevation, the alignment of the highway shows a slope of 0,9% (Figure 2).

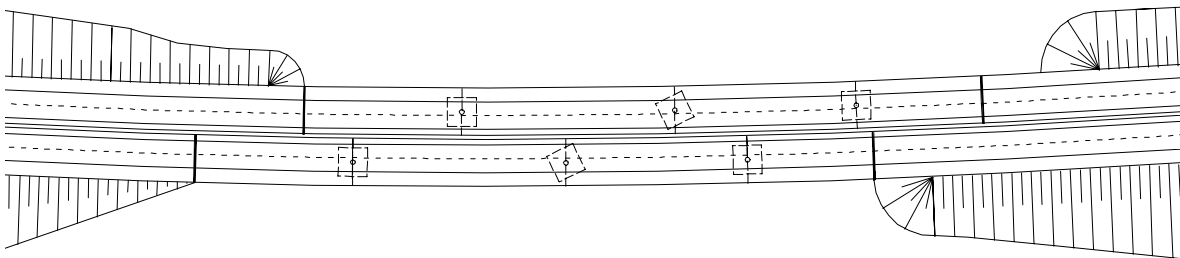


Figure 1. Plan view of the highway bridge to be designed and built

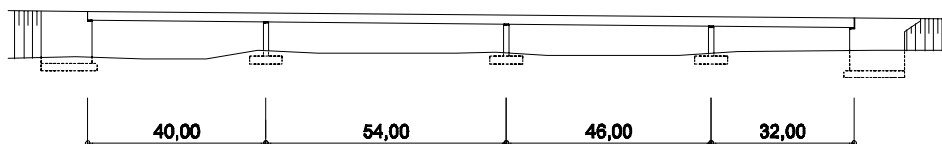


Figure 2. Elevation of the highway bridge

2.2 Functionality

The bridge is planned to carry a carriageway with two lanes, 3,5 m wide, in both directions. Furthermore, on either side of the two carriageways two shoulders are accommodated, respectively 2,5 m and 1,5 m wide (Figure 3). The expected traffic on the future route responds to a common traffic composition for highways since it is not classified as a route for special vehicles. Heavy

industrial international traffic is also not expected.

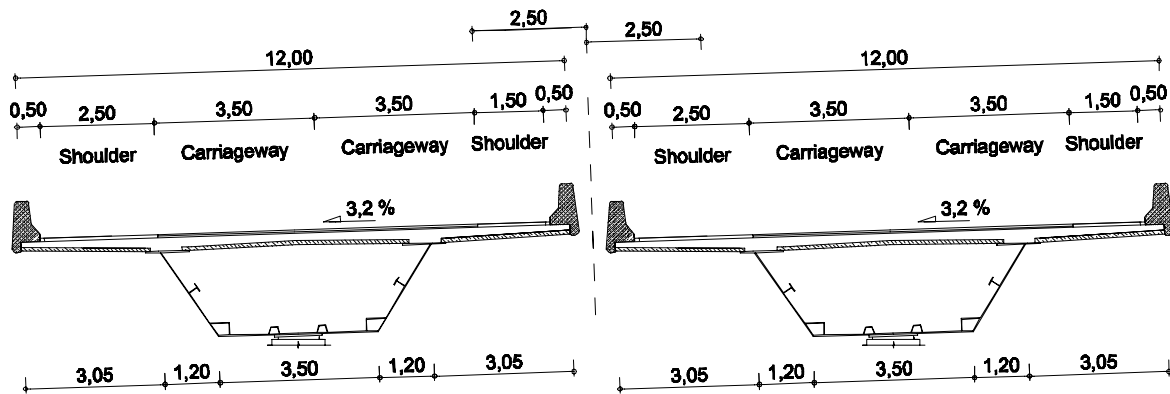


Figure 3. Required cross-section for the highway

2.3 Construction

No traffic interruption is possible on the highway to be crossed by the new bridge. Temporary supports are therefore not allowed during the construction of the bridge. Extensive use of prefabrication techniques should be made and the adopted solution should also allow to increase the ease and speed of assembly and erection in order to minimize interference with the traffic on the existing highway. A solution with composite steel and concrete members is particularly indicated in the present case.

3. Conceptual design

3.1 Layout of the bridge

A solution is adopted with two independent bridge decks carrying two lanes of traffic and two shoulders each. A vehicle restraint system is situated on either side of each deck, being therefore its total width 12 m (Figure 3). The total length of the bridge of 172 m is divided into 4 spans with span lengths of, respectively, 40 m – 54 m – 46 m – 32 m (Figure 2). Each of the two decks is supported by 3 intermediate piers composed of a single shaft with a circular cross-section. In plan, the alignment of the piers is parallel to the existing highway and roads to be crossed by the new bridge (Figure 1).

3.2 Bridge deck

Each of the two independent bridge decks is constituted by a continuous composite single cell box-girder. The two decks being identical, the following considerations refer to only one of them.

The open steel box is of constant height, 1850 mm, with a trapezoidal shape, being its width 3500 mm at the bottom and 5900 mm at the open top (Figure 3). The concrete deck is constituted by precast slabs and in situ concrete. The function of the precast slabs (12 m · 3 m · 0,085 m) is twofold since they are used as formwork for the casting of the in situ concrete. At the final stage, the precast slabs and the in situ concrete (variable thickness between 0,115 m and 0,265 m according to the shape of the cross-section of the bridge deck) constitute a monolithic slab. In order to transmit the longitudinal shear forces between the concrete and the structural steel, appropriate voids are left open in the precast concrete slabs where groups of stud connectors are welded to the top flanges of the steel box girder (Figure 4). These connectors will be surrounded by the in situ concrete after its pouring in a way that the composite action of the steel box and the concrete deck is guaranteed.

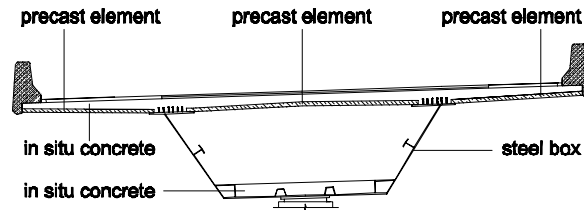


Figure 4. Cross-section with double composite action over the internal supports

The thickness of the webs of the steel box girder is variable between 12 mm and 18 mm. The top flanges are of constant width, 700 mm, whereas their thickness is variable between 25 mm and 50 mm. Finally, the thickness of the bottom flange varies between 12 mm and 35 mm. In order to assure the stability of the box girder as well as of the different steel plated elements, a series of diaphragms, longitudinal and transverse stiffeners are provided. Additionally, the bottom flange is stiffened with concrete in the hogging bending region. The steel flange is connected to this concrete of constant thickness of 0,27 m by means of stud connectors. In this way, the bottom flange is also composite over the internal supports and the bridge deck is of the type with a so-called double composite action. This conceptual design allows to avoid plate buckling of the compression flange and a ductile structural behaviour can be reached. This topic will be revisited in section 4.3 where its importance will be emphasised.

3.3 Construction

The construction of the bridge includes the following stages:

1. Erection of the steel structure. According to the aforementioned boundary conditions no temporary supports can be used (Section 2.3).
2. Casting of the bottom flange concrete over the internal supports.
3. Placing of the precast slabs.
4. Casting of the top flange in situ concrete by using the precast slabs as formwork.
5. Placing of vehicle restraint system, asphalt layer, etc.

For the purpose of the present case study, the following simplifications are assumed:

- The precast slabs are placed in one single step.
- The in situ concrete is cast in one single step over the whole length of the bridge.
- All dead loads, mainly the vehicle restraint system and the asphalt layer, are applied at the same time, two weeks after the pouring of the in situ concrete.

4. Actions, influences and countermeasures

4.1 Introduction

Structural reliability is strongly related to the recognition of the actions and the influences to which the structure might be exposed during execution and use. The goal is to recognise all actions and influences likely to occur. Only then a solution can be found that meets the basic requirements according to [EN 1990], Clause 2.1, as mentioned in section 1.3 of the present contribution. Due to the importance of this step, the actions and influences that might be relevant for the bridge deck of the present case study are discussed in the following.

The required levels of reliability relating to structural resistance and serviceability may be reached by applying suitable countermeasures or combinations of such measures ([EN 1990], Clause 2.2.(5)) in order to eliminate, by-pass, control or overcome the effects of the actions and the influences. These measures are applied in technical and in organisational areas and, generally,

everywhere where human errors can be avoided. They refer to all phases of the construction process, from the design over the construction, to the utilisation and even to the decommission phase if relevant. In the following, the adopted measures to prevent potential causes of failure are indicated for all recognised actions and influences. Furthermore, the phase of the application of each of these measures is also mentioned.

Different actions and influences occur together in space and time in a way that situations can arise that are potentially more dangerous than those with individual actions or influences acting alone. According to [EN 1990], Clause 3.2.(3)P, design situations are to be selected that are "... sufficiently severe and varied so as to encompass all conditions that can reasonably be foreseen to occur during the execution and use of the structure". Once the actions and the influences to which the structure might be exposed are recognised, and a combination of appropriate countermeasures is chosen, the design situations for the verification of the Ultimate and the Serviceability Limit States, respectively, can be established. The required selection of the relevant situations ([EN 1990], Clause 3.2.1(P)) for the structural design of the bridge deck is also treated in the following.

4.2 Recognition of actions and influences, adoption of countermeasures

4.2.1 Permanent actions

Self-weight of steel structure

According to the assumed construction procedure (section 3.3), the self-weight of the steel structure is to be sustained by the steel structure alone. In order to achieve the required reliability levels relating to structural resistance and serviceability, the following *measures* are applied:

- The self-weight of the steel structure is taken into account in the design calculations on the basis of its nominal dimensions and the mean unit mass of steel according to [EN 1991-1-1], and by using partial factors according to [EN 1990 prA2].
- Quality Assurance (QA) measures are adopted in order to ensure that the dimensions of the steel structure correspond to the assumptions made in the design (tolerances). Furthermore, it must also be ensured that the sequence of assembly of the steel structure corresponds to the sequence adopted in the design calculations.

The first of the two aforementioned measures refers to the design phase and the second, to the construction phase. The adopted measures for achieving the required reliability level are listed in Table 1 for all recognised actions and influences, together with the phase of the construction process to which they refer.

Self-weight of precast concrete slab

Similarly to the self-weight of the steel structure, the precast concrete slabs are sustained by the steel structure alone. The adopted *measures* for achieving the required reliability level are also equivalent to the measures from the previous case: The self-weight enters the design calculations with its nominal value according to [EN 1991-1-1] and by using partial factors from [EN 1990 prA2]. During the construction phase, QA measures are applied in order to ensure that the dimensions of the slabs as well as the sequence of their placing are in accordance with the assumptions made in the design.

Self-weight of in situ concrete

According to the assumed construction procedure (section 3.3), as well as the precast concrete slabs, the in situ concrete acts on the steel structure alone. According to [prEN 1991-1-6], Clause 4.11.2, structural safety and serviceability of the steel structure during construction are to be verified by taking into account the weight of the fresh concrete [EN 1991-1-1]. On the other hand, for the corresponding verifications of the composite structure at the final stage, the normal weight of in situ concrete can be used. The self-weight is calculated on the basis of the nominal dimensions and the verifications are carried out by using partial factors from [EN 1990 prA2]. With a view to ensuring that the dimensions of the in situ concrete and the sequence of its pouring correspond to the design assumptions, adequate QA measures are put into practice during execution.

Table 1. Actions, influences and measures adopted for achieving the required reliability level

Class of Actions	Action, Influence	Measures for achieving reliability level	Phase of application	
Permanent Actions	Self-weight steel structure	- Design calculations - QA (Dimensions; Sequence of assembly)	Design Execution	
	Self-weight precast concrete slabs	- Design calculations - QA (Dimensions; Sequence of placing)	Design Execution	
	Self-weight in situ concrete	- Design calculations - QA (Dimensions; Sequence of casting)	Design Execution	
	Dead loads		- Design calculations	Design
			- QA (Materials; Dimensions)	Execution
			- Monitoring of possible changes	Maintenance
	Creep and shrinkage		- Conceptual design (Ductile system)	Design
			- Design calculations	Design
			- Minimum reinforcement	Design
	Uneven settlements		- QA (Placing of reinforcement; Curing; etc.)	Execution
		- Conceptual design (Ductile system)	Design	
		- Control of assumptions for soil	Execution	
Variable Actions	Construction loads	- Inspection	Maintenance	
		- Design calculations	Design	
	Rainfall	- QA (Avoid improper storage of materials)	Execution	
		- Drilling holes in steel box	Execution	
		- Drainage system for bridge deck	Design	
	Wind	- Cleaning of drainage system	Maintenance	
		- Design calculations (Bearings; Piers; Abutments; Foundations)	Design	
	Temperature	- Conceptual design (Ductile system)	Design	
		- Design calculations	Design	
		- Minimum reinforcement	Design	
	Traffic loads	- Design calculations (no special vehicles)	Design	
		- Vertical loads		
		- Braking and acceleration (Bearings; Piers)		
		- Re-surfacing (Reduction of dynamic effects)	Maintenance	
		- Efficient drainage system	Design	
	Environmental actions	- Sealing of carriageway	Design	
- Concrete cover		Design		
- Concrete quality		Design		
- Detailing		Design		
- Protective coating of steel structure		Design		
- QA		Execution		
- Cleaning of drainage system		Maintenance		
- Renewal of protective coating		Maintenance		
Accidental Actions	Failure of pier due to impact	- Protective measure (Vehicle restraint system)	Design	
	Seismic action	- Conceptual design (Ductile system)	Design	
		- Design calculations (Piers; Abutments; Foundations)	Design	

Dead loads

The dead loads are mainly constituted by the vehicle restraint system and the asphalt layer. According to the assumed construction procedure (section 3.3), the dead loads are sustained by the composite structure. For the achievement of the required reliability, the following combination of *measures* is adopted:

- The self-weight of the vehicle restraint system enters the design calculations with its nominal value, whereas for the asphalt layer the upper characteristic value is used according to [EN 1990], Clause 4.1.2.(4). Partial factors according to [EN 1990 prA2] are applied to both of the aforementioned values.
- During the construction phase, QA measures are applied in order to ensure that the dimensions of the vehicle restraint system and the thickness of the asphalt layer, as well as the materials used for the non structural elements correspond to the assumptions made in the design.

- Monitoring of possible changes on the occasion of maintenance works during the design working life of the infrastructure (e.g. control of thickness of asphalt layer on the occasion of re-surfacing; control of self-weight of a new vehicle restraint system).

Creep and shrinkage

The effects of creep and shrinkage on the composite structure are mitigated by means of the conceptual design leading to a ductile behaviour. Additional *measures* such as providing a minimum reinforcement at the design phase, or adequate curing of the concrete during execution also contribute to the mitigation of these effects. Apart from these conceptual and constructive measures, creep and shrinkage are taken into account in the design calculations according to [prEN 1994-2], Clause 5.4.2.2. Finally, QA measures are applied during the construction phase in order to ensure that the execution (placing of reinforcement; curing of concrete; etc.) is in accordance with the assumptions made in the design.

Uneven settlements

Uneven settlements of the foundations of the piers or the abutments may lead to important deformations, internal forces and moments in the composite bridge girder. The sensitivity of the system to these effects is considerably reduced by conceiving, at the conceptual design stage (section 3.2), a structure with a ductile behaviour. Further *measures* are adopted with a view to achieving the required level of structural reliability. The quality of the parameters describing the properties of the soil, established in geotechnical investigations at the design stage, is to be confirmed or improved during execution. In case differential settlements should occur, adequate inspection during the phase of utilisation and maintenance of the bridge allows their detection at an early stage and the adoption of countermeasures, thus avoiding potential damage to the bridge or to the users.

The required levels of reliability relating to structural resistance and serviceability are achieved by the combination of these technical and organisational measures. Therefore, the effects of uneven settlements are not taken into account in the design calculations for the bridge deck.

4.2.2 Variable actions

Construction loads

The effects of the construction loads are particularly important during the casting of the in situ concrete when they are to be sustained by the steel structure alone. In order to achieve the required reliability level, the construction loads during the casting of the concrete, defined in [prEN 1991-1-6], Clause 4.11.2, are taken into account in the design calculations, together with the partial factors established in [EN 1990 prA2], Table A2.4(B). Additional QA *measures* are adopted during execution in order to avoid improper storage of construction materials, equipment, etc., thus preventing potential causes of failure.

Rainfall

The time interval between the erection of the steel structure and the construction of the concrete slab is unknown *a priori* and water from rainfall could therefore accumulate in the open steel box. In order to prevent this potential cause of failure, holes are drilled in the bottom flange, thus ensuring the drainage of the steel box.

An efficient drainage system is also to be designed for the final bridge. During utilisation of the bridge, this system is to be maintained properly.

Wind

Wind loads are not normally decisive for the design of this type of box girders for short and medium span bridges. However, the forces due to the wind acting on the bridge deck and on the vehicles crossing the bridge are, of course, to be transferred to the foundations. Therefore, they are taken into account in the design calculations for, respectively, the bearings, the piers, the abutments and the foundations. Wind actions are modelled according to [prEN 1991-1-4.6].

Temperature

The ductile structural behaviour of the bridge deck, achieved by means of its conceptual design,

contributes to the mitigation of the temperature effects. Temperature induced cracking of the concrete slab is controlled providing a minimum reinforcement. Additionally to the aforementioned *measures*, following [prEN 1994-2], Clause 5.4.2.5.(2), temperature effects are taken into account in the design calculations since cross-sections of usual composite bridges belong to Class 4 according to the classification system defined in [prEN 1994-2], Clause 5.5, and [prEN 1993-1-1]. Representative values due to temperature are established in accordance with [prEN 1991-1-5] and deriving minimum and maximum shade air temperatures for the site from the maps of isotherms included in [Ministerio de Medio Ambiente 2004], compatible with the principles from [EN 1990], Clause 4.1.2.(7)P. These representative values are used in combination with the corresponding partial factor chosen from [EN 1990 prA2], Table A2.4(B).

Traffic loads

Road traffic actions are taken into account in the design calculations of the bridge deck. To this end, the models from [EN 1991-2] are applied. Since the bridge does not belong to a route permitted for abnormal traffic (Section 2.2), no load models representing special vehicles are taken into account. For the design of the composite bridge girder, the characteristic values of the vertical loads according to [EN 1991-2], Clause 4.3, are used together with the partial factors indicated in [EN 1990 prA2], Table A2.4(B). For the design of bearings and piers, braking and acceleration forces according to [EN 1991-2], Clause 4.4, are additionally taken into account.

An adequate bridge maintenance program is put into practice. This includes re-surfacing at given time intervals thus reducing the dynamic effects. This additional *measure* mainly contributes to extend the fatigue life of the bridge and the service life of elements such as the bridge bearings.

Environmental actions

Although not directly exposed to a marine environment, the bridge is located close to the Mediterranean coast. The environmental conditions to which it is exposed may induce chemical and physical processes leading to the deterioration of the structure. In order to ensure that these processes do not reduce the reliability relating to structural resistance and serviceability below the required levels, a series of *measures* are adopted mainly, but not exclusively, of conceptual, preventative and protective nature. All these measures, as well as the phases of the construction process to which they refer are listed in Table 1 without further explanation.

4.2.3 *Accidental actions*

Failure of pier due to impact

The risk of failure of one of the piers (with the subsequent failure of the bridge deck) due to the impact of vehicles circulating on the existing highway crossed by the new bridge is reduced to an acceptable level by means of a *protective measure*. The piers are protected by an adequate vehicle restraint system. The risk of failure of this system is considered as being acceptably small. Consequently, the bridge piers are not designed for impact from vehicles.

Seismic actions

The conceptual design of the bridge, leading to a system with a ductile behaviour, reduces the sensitivity of the system to the seismic actions. Since the bridge is situated in a region with a low seismic risk [IAP], the bridge girder shows an adequate capacity for dissipation of energy and the required level of reliability relating to structural resistance is reached by means of this *conceptual measure*. Seismic actions, however, are taken into account in the design calculations for, respectively, the piers, the abutments and the foundations. These calculations are beyond the scope of the present contribution.

4.3 Failure mode and reliability

The failure mode of a structural system strongly depends on its behaviour, ductile or brittle. A brittle cross-section becomes inactive when reaching its ultimate strength, thus possibly leading to a progressive collapse of the whole system. On the other hand, if the same cross-section shows a ductile behaviour it is still active after attaining its ultimate strength and redistributions of internal forces and moments are possible. It can be shown [Tanner 2002] that a bridge with a brittle behaviour is considerably less reliable than a similar system with a ductile behaviour. In other

words, compared to a structure with a brittle behaviour, a ductile system has an additional safety margin. The incidence of the failure mode is even more important if we bear in mind that the sensitivity of a structure to the uncertainties of action effects such as creep, shrinkage, temperature, differential settlements, or seismic actions is reduced through a ductile behaviour whereas in a brittle structure collapse can occur suddenly, without prior warning. For all these reasons, the conceptual design of a ductile composite bridge has been emphasised in the previous sections of this case study and potential failures caused by the aforementioned actions and influences are prevented by this conceptual measure and other technical or organisational measures rather than by design calculations. However, a specific comment must be made concerning the effects of temperature and shrinkage of concrete. For the aforementioned reasons, according to some design rules, e.g. [RPX-95], the effects of temperature and shrinkage may be neglected in the analysis for the ultimate limit states of composite bridges if a ductile behaviour of all cross-sections is guaranteed, even if local plate buckling can occur. The Eurocode for the design of composite bridges [prEN 1994-2] is more conservative since according to the Clauses 5.4.2.2.(7) and 5.4.2.5.(2), respectively, shrinkage and temperature effects only can be neglected in analysis for ultimate limit states if all cross-sections are in Class 1 or 2. In daily practice this is almost never the case since most composite bridges include cross-sections with slender steel plated elements belonging to Class 4 according to [prEN 1994-2], Clause 5.5. Particularly, the cross-sections of the hogging bending region of the bridge analysed in the present case study are slender (Class 4) and shrinkage and temperature effects are to be taken into account in the analysis for the verifications of ultimate limit states.

4.4 Relevant design situations

4.4.1 Overview

The actions and influences to which the bridge might be exposed and that constitute potential causes of failure for the bridge deck from the present case study have been discussed. As mentioned in Section 4.2, the measures adopted for reaching the required levels of reliability relating to structural resistance and serviceability may well be different from providing structural reserves by means of design calculations. Therefore, according to the considerations from Sections 4.2 and 4.3, the following actions and influences are to be taken into account in the calculations to be carried out with a view to design the bridge deck. The symbols used for the continuation of the example are also indicated:

- Self-weight steel structure, G_a .
- Self-weight concrete slab, G_c .
- Dead loads, G_{dl} .
- Shrinkage, G_{cs} .
- Self-weight precast concrete slabs, Q_{cc} .
- Self-weight fresh in situ concrete, Q_{cf} .
- Construction loads, Q_{ca} .
- Temperature, T .
- Traffic loads, Q .

In the following, the relevant design situations are selected for the verification of, respectively, structural safety and serviceability of the bridge deck. Consequently, it is distinguished between design situation for Ultimate Limit States (ULS) and Serviceability Limit States (SLS). According to the scope of this contribution, safety against fatigue is not considered in this example.

4.4.2 Design situations for the verification of Ultimate Limit States

The situations to be taken into account in the verifications of structural safety of the bridge deck are listed in Table 2. Normally (with the exception of the situation related to the construction of the deck), they are designated according to the leading variable action.

Table 2. Design situations for the verification of Ultimate Limit States related with the bridge deck (except fatigue)

Design situation		Permanent actions			Variable actions	
Designation	Class	Self-weight structure	Self-weight non structural elements	Others	Leading	Accompanying
Construction	Transient	G_a			Q_{ef}	Q_{cc} , Q_{ca}
Traffic	Persistent	G_a ; G_c	G_{dl}	G_{cs}	Q	T
Temperature	Persistent	G_a ; G_c	G_{dl}	G_{cs}	T	Q

During construction, the self-weight of both, the precast concrete slabs and the fresh in situ concrete are to be considered as variable actions. Construction loads, of course, are also considered as variable action. Since the self-weight of the fresh concrete is larger than the self-weight of the precast slabs and also larger than the construction loads, a priori it is obvious that the fresh concrete constitutes the leading variable action. Therefore, only one design situation is to be taken into account for the verification of structural safety of the open steel box girder during construction according to [prEN 1993-1-1] and [prEN 1993-2].

At the final stage, the precast concrete slabs and the in situ concrete constitute a monolithic concrete slab and act together with the steel structure as composite box girder. Therefore, the concrete deck is to be considered as structural element and no longer as variable action. Since a priori it is not clear whether the situation *Traffic* is critical for the design of all structural elements of the composite girder including shear connection, two persistent design situations are taken into account: In the first one, the traffic loads constitute the leading variable action and the temperature is the accompanying variable action, and the second one with the temperature as leading variable action and the traffic loads as accompanying variable action.

4.4.3 Design situations for the verification of Serviceability Limit States

According to [EN 1990], Clause 6.5.3.(1), the design situations to be taken into account for the verification of the serviceability requirements depend on the performance criteria being verified. Performance criteria refer to [EN 1990], Clause 3.4.(1)P:

- The functioning of the structure, the finishes or other non-structural members.
- The comfort of users.
- The appearance of the construction works.

In the present case study, only the design situations for the verification of the Serviceability Limit States related to the deformations of the structure are considered. It must be distinguished between the construction of the bridge and its final stage. Deflections due to the loading applied to the steel box girder alone are compensated by a precamber in the unloaded structural member. Additionally, for the exact definition of this precamber, the self-weight of non-structural elements acting on the composite structure as well as the influence of creep and shrinkage are to be taken into account.

The design situations for the verifications of the serviceability requirements concerning the deformations of the bridge deck are listed in Table 3. Different situations are taken into account for different performance criteria. When verifying the performance criteria *Functioning* and *Appearance*, long term effects as well as the precamber in the unloaded steel structure are to be taken into account in the establishment of the deformations.

Table 3. Design situations for the verification of Serviceability Limit States concerning the deformations of the bridge deck

Verification criteria: Deformations		Permanent actions			Variable actions	
Performance criteria	Combination	Self-weight structure	Self-weight non structural elements	Others	Leading	Accompanying
Functioning	Frequent	G_a ; G_c	G_{dl}	G_{cs}	Q	T
Comfort	Frequent				Q	
Appearance	Quasi-permanent	G_a ; G_c	G_{dl}	G_{cs}	Q	T

Although not further treated in the present case study, it should be mentioned that additional serviceability requirements are to be verified in order to reach all aforementioned performance criteria:

- Stress limitations; according to [prEN 1992-2], Clause 7.2, for the reinforced concrete slab and according to [prEN 1993-2], Clause 7.3, for structural steel.
- Web breathing; according to [prEN 1993-2], Clause 7.4.
- Cracking of concrete; according to [prEN 1992-2], Clause 7.3.
- Vibrations are normally not relevant in medium span road bridges without pedestrian traffic.

5. Action models

For the purpose of bridge design, models are to be established for the relevant actions, listed in Section 4.4.1. The models must be site specific (Sections 2.1 and 2.2) and consistent with the conceptual design of the bridge (Section 3). For the assessment of these loads, the different parts of the Eurocodes, as mentioned in previous sections of this contribution, are to be used. No particular difficulties arise when applying these rules to the present bridge. Therefore, in the following only a few remarks concerning the shrinkage of the concrete are included.

For the assumed construction process (Section 3.3) only the shrinkage of the in situ concrete is of practical importance. The final value of the total shrinkage strain in the cast in situ concrete can be established according to [prEN 1992-1-1], Clause 3.1.4. This value allows to estimate the final total shrinkage of the concrete slab if it was not restrained. However, in the case of a composite element, shrinkage is restrained by the shear connection. Therefore, the shrinkage of the slab induces compression forces on the composite deck, applied at both ends of the bridge, at the level of the centre of gravity of the in situ concrete. When estimating these forces, the influence of creep is to be taken into account according to [prEN 1994-2], Clause 5.4.2.2. Due to the eccentricity of the concrete slab with respect to the neutral axis of the composite cross-sections, each of the aforementioned compression forces is normally substituted by a bending moment and a compression force acting at the level of the centre of gravity of the cross-sections at both abutments (Figure 5). By applying these forces and moments, the effects of shrinkage on the composite beam can be estimated (internal forces, moments and deformations). In the present case, the influence of the double composite action is to be taken into account. The forces and moments to be applied to the beam due to the shrinkage of the bottom flange concrete are established in the same way as for the top flange concrete.

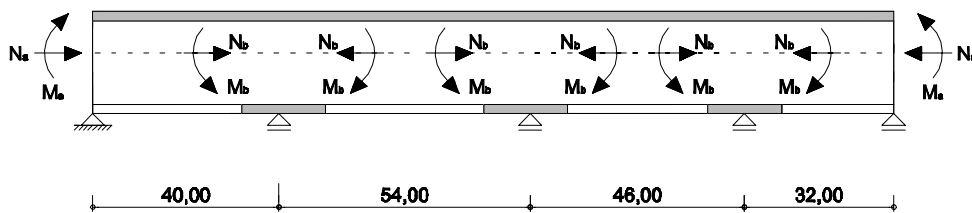


Figure 5. Schematic representation of the forces and moments to be applied in order to estimate the effects of shrinkage

6. Calculation of action effects

Action effects may be calculated by elastic analysis even if resistance calculations are based on the non-linear behaviour of the structure [prEN 1994-2], Clause 5.4.1.1.(1). In the present case, elastic analysis is used for the calculation of the action effects for the verification of both, the Serviceability and the Ultimate Limit States. The effects of the staged construction procedure is taken into account by establishing separate effects of actions applied to, respectively, the structural steel and the composite deck. Appropriate corrections are introduced for effects such as:

- Effective width of flanges due to shear lag ([prEN 1994-2], Clause 5.4.1.2).

- Creep ([prEN 1994-2], Clause 5.4.2.2).
- Cracking of concrete ([prEN 1994-2], Clause 5.4.2.3).

The effects of local buckling of steel plated elements on the stiffness is ignored ([prEN 1994-2], Clause 5.4.1.1.(6)). Local plate buckling is only taken into account in the calculation of the cross-section resistance according to [prEN 1994-1-1] and [prEN 1994-2].

7. Combination of actions

For the purpose of the verification of the relevant Ultimate Limit States, the design values of the action effects, E_d , are to be determined for each of the design situations identified in Section 4.4.2. To this end, the rules from [EN 1990] and [EN 1990 prA2] are applied.

7.1 Transient design situation *Construction*

For the transient design situation *Construction* the design value of the effects of actions and influences, E_d , is established according to [EN 1990], Clause 6.4.3.2. It may be expressed in the following terms:

$$E_d = E \left\{ \gamma_G \cdot G_{a,k} + \gamma_{Q,1} \cdot Q_{cf,k} + \gamma_{Q,2} \cdot \psi_{0,2} \cdot Q_{cc,k} + \gamma_{Q,3} \cdot \psi_{0,3} \cdot Q_{ca,k} \right\} \quad (1)$$

According to [EN 1990 prA2], Clause A2.3.1.(4), the design of structural members not involving geotechnical actions is to be carried out by using the design values of actions from Table A2.4(B). In the present case, the following partial factors are deduced from the aforementioned table:

$$\gamma_G = 1,35$$

$$\gamma_Q = 1,50$$

ψ factors for road bridges are taken from [EN 1990 prA2], Table A2.1. For construction loads:

$$\psi_0 = 1,0$$

According to these design rules, the precast concrete slabs and the in situ concrete are treated as variable actions with the same partial factor as the construction loads. This seems very conservative, particularly in the present case where QA measures are put into practice during execution in order to ensure that the dimensions of the elements and the sequence of their placing and pouring correspond to the design assumptions. Furthermore, it is not easy to understand that, apart from the reduction of the density due to the transformation of the fresh into hardened concrete, the self-weight of the concrete slab is different during execution and at the final stage, respectively.

These conservative rules may result critical for the design of the steel elements of the composite structures. In the present case, they are particularly decisive for the design of the top flanges of the steel box (resistance and lateral torsional buckling during construction).

7.2 Persistent design situation *Traffic*

The design value of the effects of actions and influences, E_d , for the persistent design situation *Traffic* is established according to [EN 1990], Clause 6.4.3.2:

$$E_d = E \left\{ \gamma_{G,1} \cdot (G_{a,k} + G_{c,k} + G_{dl,k}) + \gamma_{G,2} \cdot G_{cs,k} + \gamma_{Q,1} \cdot Q_k + \gamma_{Q,2} \cdot \psi_{0,2} \cdot T_k \right\} \quad (2)$$

The design of the composite girder is to be carried out by using the design values of actions from Table A2.4(B) since geotechnical actions are not involved ([EN 1990 prA2], Clause A2.3.1.(4)). The following partial factors are deduced from the aforementioned table:

$$\gamma_{G,1} = 1,35$$

$\gamma_{G,2} = 1,20$ This value is obtained by treating the action effects due to shrinkage as an imposed deformation, similar to the action effects due to uneven settlements.

$$\gamma_{Q,1} = 1,35$$

$$\gamma_{Q,2} = 1,50$$

ψ factors for road bridges are taken from [EN 1990 prA2], Table A2.1, obtaining in the present case

for thermal actions:

$$\psi_{0,2} = 0,6$$

7.3 Persistent design situation *Temperature*

The deduction of the design value for the action effects due to the design situation *Temperature* leads to ([EN 1990], Clause 6.4.3.2):

$$E_d = E \left\{ \gamma_{G,1} \cdot (G_{a,k} + G_{c,k} + G_{dl,k}) + \gamma_{G,2} \cdot G_{cs,k} + \gamma_{Q,1} \cdot T_k + \gamma_{Q,2} \cdot \psi_{0,2} \cdot Q_k \right\} \quad (3)$$

Also in this case, the design of the composite girder is to be carried out by using the design values of actions from Table A2.4(B) with the following partial factors:

$$\gamma_{G,1} = 1,35$$

$\gamma_{G,2} = 1,20$ This value is obtained by treating the action effects due to shrinkage as an imposed deformation, similar to the action effects due to uneven settlements.

$$\gamma_{Q,1} = 1,50$$

$$\gamma_{Q,2} = 1,35$$

ψ factors for road bridges are taken from [EN 1990 prA2], Table A2.1. In the case of Load Model 1 ([EN 1991-2], Clause 4.3.2), different values are to be used for, respectively, the Tandem System, TS, and the Uniformly Distributed Loads, UDL:

$$\psi_{0,2,TS} = 0,75$$

$$\psi_{0,2,UDL} = 0,40$$

8. Concluding remarks

The application of the Structural Eurocodes *EN 1990 Basis of Structural Design* [EN 1990] and *EN 1991 Actions on Structures* to the design of a composite steel and concrete road bridge has been studied in the present contribution. Some concluding remarks are:

- The required reliability levels relating to structural resistance and serviceability may be reached by different measures, apart from providing a sufficient load carrying capacity by means of design calculations. Such measures are generally applied in technical and in organisational areas, everywhere where the effects of actions and influences can be eliminated, by-passed or at least mitigated, or where human errors can be avoided. These measures are complementary to the design calculations.
- The sensitivity of a composite bridge to the uncertainties of the action effects or other influences may be reduced by adopting a ductile system.
- The design rules for composite bridges according to the Structural Eurocodes are conservative regarding the treatment of the actions during execution. If a ductile structural behaviour is guaranteed, they are also conservative with regard to the treatment of other actions or influences such as the shrinkage of the concrete or the temperature effects.

References

- [EN 1990] EN 1990 Eurocode: Basis of structural design. European Committee for Standardization, CEN, Brussels, April 2002.
- [EN 1990 prA2] EN 1990 prA2 Eurocode: Basis of structural design. Annex A2: Application for bridges. Final Draft. European Committee for Standardization, CEN, Brussels, June 2004.
- [EN 1991-1-1] EN 1991-1-1 Eurocode 1: Actions on structures. Part 1-1: General actions – Densities, self-weight, imposed loads for buildings. European Committee for Standardization, CEN, Brussels, April 2002.
- [prEN 1991-1-4.6] prEN 1991-1-4.6 Eurocode 1: Actions on structures. Part 1-4: General actions – Wind actions. Draft. European Committee for Standardization, CEN, Brussels, December 2003.
- [prEN 1991-1-5] prEN 1991-1-5 Eurocode 1: Actions on structures. Part 1-5: General actions – Thermal actions. Final Draft. European Committee for Standardization, CEN, Brussels, May 2003.
- [prEN 1991-1-6] prEN 1991-1-6 Eurocode 1: Actions on structures. Part 1-6: General actions – Actions during execution. Final Draft. European Committee for Standardization, CEN, Brussels, September 2004.
- [EN 1991-2] EN 1991-2 Eurocode 1: Actions on structures. Part 2: Traffic loads on bridges. European Committee for Standardization, CEN, Brussels, September 2003.
- [prEN 1992-1-1] prEN 1992-1-1 Eurocode 2: Design of concrete structures. Part 1-1: General rules and rules for buildings. Final Draft. European Committee for Standardization, CEN, Brussels, December 2003.
- [prEN 1992-2] prEN 1992-2 Eurocode 2: Design of concrete structures. Part 2: Concrete bridges. Design and detailing rules. Stage 34 Draft. European Committee for Standardization, CEN, Brussels, December 2003.
- [prEN 1993-1-1] prEN 1993-1-1 Eurocode 3: Design of steel structures. Part 1-1: General rules and rules for buildings. Final Draft. European Committee for Standardization, CEN, Brussels, December 2003.
- [prEN 1993-2] prEN 1993-2 Eurocode 3: Design of steel structures. Part 2: Steel bridges. Stage 34 Draft. European Committee for Standardization, CEN, Brussels, April 2003.
- [prEN 1994-1-1] prEN 1994-1-1 Eurocode 4: Design of composite steel and concrete structures. Part 1-1: General rules and rules for buildings. Stage 49 Draft. European Committee for Standardization, CEN, Brussels, March 2002.
- [prEN 1994-2] prEN 1994-2 Eurocode 4: Design of composite steel and concrete structures. Part 2: Rules for bridges. Stage 34 Draft. European Committee for Standardization, CEN, Brussels, February 2003.
- [IAP] IAP: Actions on road bridges. Ministry of Public Works, Madrid, 1998. ISBN 84-498-0348-9. (In Spanish).
- [Ministerio de Medio Ambiente 2004] Morata, A., Tanner, P. y Almarza, C. Evaluación de extremos meteorológicos aplicados al Código Técnico de la Edificación. Nota Técnica. Servicio de Desarrollos Climatológicos, Ministerio de Medio Ambiente, Madrid, 2004. ISBN 84-8320-273-5.
- [RPX-95] RPX-95: Recommendations for the design of composite road bridges. Ministry of Public Works, Madrid, 1996. ISBN 84-498-0223-8. (Available in Spanish and English).
- [Tanner 2002] Tanner, P. and Bellod, J.L. Increasing reliability of composite bridges by reducing steel. Ductility versus Brittleness. In: Composite Bridges. State of the Art in Technology and Analysis (Martínez Calzón, Ed.). Colegio de Ingenieros de Caminos, Canales y Puertos, Madrid, 2002. ISBN 84-380-0221-8.

APPENDIX A: PROPERTIES OF SELECTED MATERIALS

Igor Kovše¹, Angel Arteaga²

¹Metal Construction Institute, Ljubljana, Slovenia

²Eduardo Torroja Institute for Construction Research - CSIC, Madrid, Spain

Summary

Material properties are relevant to the structural design process because of their effect on the strength, serviceability and durability of structures. In a previous handbook [1] a number of models for materials and their respective properties were addressed in the chapter devoted to properties of the structural materials for building structures. The specific properties of structural steel and concrete and the methods for determining their characteristic and design values were discussed in greater detail. The reader is addressed to that handbook in order to know most of the points of interest of the materials; this chapter intend to present only those aspects of the materials more relevant in the case of its use in bridges.

1 PROPERTIES OF CONCRETE

1.1 Introduction

The concrete used in bridges do not defer sensibly of the concrete used in buildings structures, therefore so occur with its properties. Differences between these two types of structures, from the point of view of the concrete use, may be summarized in two main aspects: in the bridges the structure is always in the “open air” and therefore submitted directly to the environmental influences, and so, prone to present problems of durability; and, in the other side, the scatter between the Quality Control measures implemented in the bridges is less related with the importance of the bridge that in the case of buildings, where the differences between in QC in a small house or a big building is much more notorious.

The use of prefabrication, prestressing reinforcement and other “refined” techniques in bridges is more common than in buildings and therefore the importance of the evolution in time of the properties of the concrete: strength, elastic modulus, creep and shrinkage, in the early ages as well as in long time.

1.2 Concrete classes

As is said the [1] in the chapter devoted to structural materials properties, in EN 1992-1-1 (Design of concrete structures: General rules and rules for buildings) [2]) the concrete strength classes are based on characteristic compressive strength, f_{ck} . In the case of bridges, there are recommended minimum and maximum values of this strength, 30 and 70 MPa. That is the range of recommend values is less wide that in the case of buildings, in the lower part as well as in the upper part.

If no accurate testing data are available, the different strengths and elastic modulus associated with these classes can be seen in Table 3, of chapter of the mentioned handbook.

The design values of the compressive and tensile strength of concrete are calculated from the following expressions:

$$f_{cd} = \alpha_{cc} f_{ck} / \gamma_c, \text{ and } f_{ctd} = \alpha_{ct} f_{ctk; 0,05} / \gamma_c;$$

where:

γ_c is the partial safety factor for concrete. The recommended value is 1,5 for persistent and transient situations and 1,2 for accidental situations.

α_{cc}, α_{ct} are coefficients taking account of long-term effects and the way the load is applied. They should lie between 0,80 and 1,00.

1.3 Time-dependence of concrete mechanical parameters

As stated in [1], most of the concrete properties are heavily dependent on time. Concrete strength increases with time, more or less quickly depending of the kind of cement and curing conditions. Although values continue to rise for much longer, after the age of 28 days the rate of increase slows considerably. The same pattern is observed for the elastic modulus. The effects of other properties, such as creep and shrinkage, also lengthen the time needed to reach what might be regarded to be a steady state.

The formulae, tables, and figures given in Handbook 3 are valid for the assessment of the time variation of the compressive strength and elastic modulus also in the case of bridges. But maybe in bridges could be often more appropriate the direct assessment of these properties by means of oriented tests.

1.4 Creep and shrinkage

The formulae given in [1] are still valid when considering the concrete in bridges. A first consideration has to be noted: the real value of the coefficients of creep and shrinkage present a big scatter relative to the theoretical values obtained with the formulae given; therefore, if the bridge is sensitive to these deformations, and so it is often, the use of experimental values of the kind of concrete actually to be employed is strongly recommended.

In Annex B of EN 1992-2 are given formulae for high strength concrete ($f_{ck} > 50/60$ MPa), both silica-fume concrete and non silica-fume concrete.

1.5 Durability

The bridge structures differ of the buildings structures in various important aspects:

- the bridge is its own structure;
- for its very nature, they have to solve technical difficulties: long spans, heavy weights; - have to deal with the environment as it is, they are not protected from outdoors.

All these reasons make the bridges more sensitive to the problems of durability than the buildings structures. But, notwithstanding this statement, the durability problem can be dealt with in the same way in both cases. In fact all recommendations related with durability are included in the general part of the EN 1992 [2] for all kind of structures.

Some attempts have been made in order to deal with this issue in the same way we deal with other actions; that is: defining probabilistically the environmental actions, its effects, the resistance of the structure and the Limit States, as indicated in EN 1990 [4], see, for instance, [5].

The most common way of solving this problem, and the way is implemented in [3], is by the use of deemed to satisfy rules, forcing the use of minimum concrete quality and cover thickness.

In order to state these rules [2] defines, in first place, the different environments that can influence the structures from the point of view of durability:

- 1 no risk of attack, X;
- 2 corrosion induced by carbonation, XC;
- 3 corrosion induced by chloride, XD;
- 4 corrosion induced by chlorides from the sea water, XS;
- 5 freeze/thaw attack, XF; and
- 6 chemical attack, XA.

For each one of these environments, but for the first one, in Table 4.1, are established three or four degrees of attack, Exposure Class, 1 to 3 or 4, from less to more severe attack. Then, for each degree and kind of environment, the Annex E recommends the minimum concrete class, from C20/25 to C35/45.

The following step is to define the Structural Class, from S1 to S6. Starting from the class S4, the class is increased or reduced depending of: the design working life, the strength class, the member geometry (slab or not) or ensured Quality Control, Table 4.3N.

Finally, for each Structural Class and each Exposure Class a minimum cover thickness for durability reasons, $c_{\min, \text{dur}}$, is required in Tables 4.4N and 4.5N, for reinforcement steel or prestressing steel respectively.

This minimum cover for durability can be corrected following the indications of the National Annex, if they stated it, taking account of an additional safety margin or the use of stainless steel or additional protection.

The final minimum cover thickness is not fixed only by the durability reasons, but it also takes account of the need of cover to assure the bond between the steel and the concrete. The minimum cover for bond, $c_{\min, \text{b}}$, is given the diameter of the reinforcement, in the case of separated bars, or the equivalent diameter, \varnothing_n , in the case of bundle bars.

The equivalent diameter is defined by the formula $\varnothing_n = \varnothing \cdot n_b$, where: \varnothing is the individual bar diameter, and n_b the number of bars in the bundle, limited to 4 in the case of vertical bars in compression or bars in a lapped joint, and to 3 in other cases.

The final minimum cover is defined as:

$$c_{\min} = \max\{c_{\min, \text{b}}; c_{\min, \text{dur}}; 10 \text{ mm}\}.$$

From this minimum cover, a nominal cover, c_{nom} , the value included in the drawings, is obtained adding to this minimum cover an allowance in design for deviation, Δc_{dev} :

$$c_{\text{nom}} = c_{\min} + \Delta c_{\text{dev}};$$

The value of Δc_{dev} can be defined in the National Annex.

As an illustrations of these rules the following a simple example is given:

Example

A reinforced concrete bridge near the sea shore and submitted to de-icing salts on the deck.

Design characteristics:

Working life	100 years
Column and beams concrete	C 40/50
Deck concrete	C30/37
Maximum bar diameter	25 mm

Minimum cover:

Conditions	Columns and beams	Deck
Exposure class (Table 4.1)	XS 1	XD 3
Minimum strength class (Annex E)	C30/37	C35/45 ¹
Adopted strength class	C40/50	C35/45
Initial structural class	S4	S4
Design working life 100 yr (Table 4.3N)	+2	+2
Strength class (Table 4.3N)	-1	=
Member slab geometry (Table 4.3N)	=	-1
Special Quality Control	=	=
Final Strength Class	S5	S5
Minimum cover for durability (Table 4.4N)	40 mm	50 mm
Minimum cover for bond (Table 4.2)	25 mm	25 mm
Minimum cover, c_{min}	40 mm	50 mm

¹This strength class is higher than the first chosen in the design, we adopt this new strength class for the slab.

2 REFERENCES

[1] Leonardo HB3
 [2] EN 1992-1-1 Eurocode 2: Design of concrete structures – Part 1-1: General rules and rules for buildings. Brussels, 2005
 [3] EN 1992.2 Eurocode2 - Eurocode 2: Design of concrete structures – Part 2: Bridges
 [4] EN 1990 Eurocode - Basis of structural design. CEN 2002.
 [5] A.J.M. Siemes, A.C.W.M. Vrouwenvelder, A. van den Beuken: Durability of buildings: a reliability analysis, *Heron*, vol 30, 1985.